

LP Power Analyzer

UMG 96-PQ-L-LP

(as of firmware 3.50)

User manual and technical data

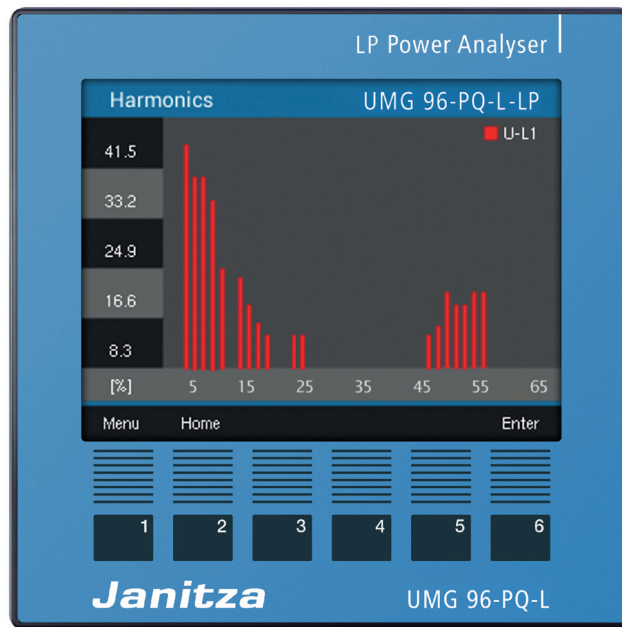

Image may differ from the original!

UMG 96-PQ-L-LP (as of firmware 3.50)

Measurement device for recording energy quantities

Doc. no.: 2.061.120.1.b

11/2023

The German version is the original edition of the documentation.

Subject to technical alterations.

The contents of our documentation have been compiled with great care and reflect the current state of the information available to us. Nonetheless, we wish to point out that updates of this document are not always possible at the same time as technical refinements are implemented in our products. Information and specifications are subject to change without notice.

Please check for the latest version at www.janitza.com.

Information about the GridVis® software.

 Janipedia: wiki.janitza.de

 Tutorials: youtube.com/@gridvis

TABLE OF CONTENTS

1. Information on the device and the user manual	10
1.1 Disclaimer	10
1.2 Copyright notice	10
1.3 Technical changes	10
1.4 About this user manual	10
1.5 Defective device/disposal	11
2. Safety	12
2.1 Display of warning notices and safety information	12
2.2 Hazard levels	12
2.3 Product safety	12
2.4 Dangers when handling the device	13
2.5 Electrically qualified personnel	14
2.6 Warranty in the event of damage	14
2.7 Safety information for handling current transformers and measurement devices with residual current measurement	14
2.8 Handling batteries/accumulators	15
3. Product description	16
3.1 Device description	16
3.2 Device versions	16
3.3 Incoming goods inspection	16
3.4 Intended use	17
3.5 Performance characteristics	17
3.6 EU conformity declaration	18
3.7 Scope of delivery	18
3.8 Accessories	18
3.9 Measuring method	19
3.10 Transformers	19
3.11 Operating concept	19
3.12 GridVis® network analysis software	19
4. Structure of the device	20
4.1 Front panel - Display and controls	20
4.2 Rear of the device - Connections	21
4.3 Rating plate	22
5. Mounting	23
5.1 Installation location	23
5.2 Mounting orientation	23
5.3 Securing	23

6. Grid systems	24
7. Installation	25
7.1 Nominal voltages	25
7.1.1 Three-phase four-conductor network with grounded neutral conductor	25
7.3.1 Three-phase three-conductor system	26
7.2 Circuit breaker	26
7.3 Supply voltage	26
7.4 Voltage measurement	28
7.4.1 Overvoltage	28
7.4.2 Frequency	28
7.4.3 Connection variants for voltage measurement	29
7.4.4 Voltage transformers	30
7.5 Current measurement with low-power current transformers	31
7.5.1 Connection variants for current measurement	32
7.5.2 Current direction	33
8. Connection and PC connections	34
8.1 Connection variants	34
8.2 RS-485 interface	35
8.3 Shielding	36
8.4 Termination resistors	37
8.5 Bus structure	37
9. Digital inputs and outputs	38
9.1 Digital inputs	38
9.1.1 S0 pulse input	38
9.2 Digital outputs	39
9.3 LED status bar	39
10. Analog outputs	40
11. Operation	40
11.1 Button function	40
11.2 Measuring display “Overview”	41
11.3 Menu	41
11.4 Overview of menu displays	42
11.5 Configuring a new start screen	43

12. Configuration	44
12.1 The Configuration window	44
12.2 Language	44
12.3 Communication	45
12.4 Measurement	46
12.4.1 Current and voltage transformers	46
12.4.2 Current sensor type	47
12.4.3 I4 current transformer	47
12.4.4 Connection variant	48
12.4.6 Nominal current	50
12.4.5 Nominal frequency	50
12.5 Display	51
12.5.1 Brightness	52
12.5.2 Standby after	52
12.5.3 Brightness (standby)	52
12.5.4 Auto Home return	52
12.5.5 Home delay	52
12.5.6 Colors	53
12.6 System	53
12.6.1 Firmware/Serial number	54
12.6.2 Date/time	54
12.6.3 Password	54
12.6.4 Reset	55
12.7 Modbus editor	57
13. Commissioning	60
13.1 Applying the supply voltage	60
13.2 Measured voltage	60
13.3 Measured current	60
13.4 Frequency	61
13.5 Direction of rotary field	61
13.5.1 Fundamentals on the phasor diagram	62
13.6 Checking the voltage and current inputs using a phasor diagram	63
13.7 Overrange	63
13.8 Checking the time	63
13.9 Checking the power measurement	64
13.10 Checking the communication	64
13.11 Delete min./max. values	66
13.12 Harmonics current (harmonics)	67
13.13 Communication in the bus system	68
13.13.1 RS-485	68

13.14	Digital inputs/outputs	69
13.14.1	Digital inputs	69
13.14.2	Pulse counter (S0 input)	70
13.14.3	Digital outputs	71
13.14.4	Pulse output	71
13.14.5	Modbus remote output	72
13.14.6	Timer switch output	72
13.14.7	Comparator	73
13.15	Configuration of the analog output	75
13.16	Drag indicator function	76
13.16.1	Internal drag indicator synchronization	76
13.16.2	External drag indicator synchronization	77
13.16.3	Configuring the drag indicator synchronization	79
13.16.4	Drag indicator - Measurement device displays	80
13.16.5	Delete drag indicator	81
13.17	Gridded and moving averages	82
13.18	Recording measured values	83
13.18.1	Default setting, Partition A	84
13.18.2	Default setting, Partition B	85
13.18.3	Use cases – Recording examples	86
13.19	Events	87
13.19.1	Internal events	87
13.19.2	External events	88
13.19.3	Configuring events	89
13.19.4	Event recording time	90
13.19.5	Display of events	91
13.20	Tariff switching	92
13.21	Time synchronization	93
13.21.1	RS-485 interface (UTC time pulse)	93
13.21.2	RS-485 interface (DIN EN 60870)	93
13.21.3	Ethernet interface - measurement devices with an Ethernet module	93
13.21.4	Digital input 2	93
13.22	"Low battery" and "Set time" warnings	94

14. Overview of menus and displays	95
14.1 Overview menu (start screen)	95
14.2 Voltage menu	96
14.3 Current menu	97
14.4 Power menu	98
14.5 Energy menu	98
14.6 Consumption overview menu	99
14.7 Drag indicator menu	99
14.8 Harmonics menu	100
14.9 Oscilloscope menu	100
14.10 Events menu	101
14.11 System Info menu	103
14.12 Configuration menu – Password entry	104
14.13 Configuration menu – without password/after password entry	105
15. Service and maintenance	108
15.1 Repair and calibration	108
15.2 Front panel foil and display	108
15.3 Service	108
15.4 Device adjustment	108
15.5 Firmware update	108
15.6 Clock/Battery	109
16. Procedure in the event of a malfunction	110
17. Technical data	111
17.1 Performance characteristics of functions	114
17.2 Modbus addresses of frequently used measured values	115
17.3 Number formats	116
17.4 Note on saving measured values and configuration data	116
17.5 Dimensional drawings	117
17.6 Connection example	118

1. Information on the device and the user manual

1.1 Disclaimer

Compliance with the usage information for the devices is a prerequisite for safe operation and attaining the stated performance characteristics and product features.

Janitza electronics GmbH assumes no liability for bodily injury, material damage or financial losses which result from disregard of the usage information.

Make sure that your usage information is readily available and legible.

1.2 Copyright notice

© 2023 - Janitza electronics GmbH - Lahnau.
All rights reserved.

Any reproduction, processing, distribution or other use, in whole or in part, is prohibited.

All trademarks and the rights arising from them are the property of the respective owners of these rights.

1.3 Technical changes

- Make sure that your device matches the user manual.
- This user manual applies to the UMG 96-PQ-L-LP measurement device.
Separate validities and distinctions are marked.
- First make sure you have read and understood the usage information accompanying the product.
- Keep the usage information associated with the product available for the entire service life and pass it on to any possible subsequent users.
- Find out about device revisions and the associated modifications of the usage information associated with your product at www.janitza.com.
- This manual is also valid for alternative device fronts.

1.4 About this user manual

If you have questions, suggestions or ideas for improvement of the user manual, please let us know via email at: info@janitza.com.

INFORMATION

This user manual describes the device UMG 96-PQ-L-LP and provides information on its operation.

In addition to this user manual, please refer to additional usage information for your device, such as:

- Installation manual.
- "GridVis® software" quick guide.
- "Safety Information" supplement.

If applicable, also refer to the usage information about expansion modules, such as

- User manuals and
- Installation manual.

Moreover, the **GridVis®** software has an online help feature and e-learning modules.

INFORMATION

Our usage information uses the grammatical masculine form in a gender-neutral sense! This form always refers equally to women, men and diverse. In order to make the texts more readable, distinctions are not made. We ask for your understanding for these simplifications.

1.5 Defective device/disposal

Before sending **defective devices, modules or components** back to the manufacturer for testing:

- Contact the manufacturer's Support department.
- Send devices, modules or components complete with all accessories.
- When doing so, please bear the terms for transportation in mind.

INFORMATION

Please return defective or damaged devices to Janitza electronics GmbH in accordance with the shipping instructions for air or road freight (complete with accessories).

Observe special regulations for devices with built-in batteries or rechargeable batteries!

Do not attempt to open or repair the device (the component) on your own because otherwise all warranty claims become invalid!

For the **Disposal** of the device please observe national regulations! Dispose of individual parts, as applicable, depending on their composition and existing country-specific regulations, e.g. as

- Electronic waste,
- Batteries and rechargeable batteries,
- Plastics,
- Metals.

Engage a certified disposal company to handle scrapping as needed.

Information on servicing and maintenance of your device can be found in „15. Service and maintenance“ on page 108.

2. Safety

The chapter on Safety contains information which must be observed to ensure your personal safety and avoid material damage.

2.1 Display of warning notices and safety information

The warning notices shown below

- are found throughout all of the documentation,
- can be found on the devices themselves.
- indicate potential risks and hazards,
- underscore aspects of the information provided that clarifies or simplifies procedures.



The additional symbol on the device itself indicates an electrical danger that can result in serious injuries or death.





This general warning symbol draws attention to a possible risk of injury. Be certain to observe all of the information listed under this symbol in order to avoid possible injury or even death.



2.2 Hazard levels

Warning and safety information is marked by a warning symbol, and the hazard levels are shown as follows, depending on the degree of hazard:

 DANGER
Warns of an imminent danger which, if not avoided, results in serious or fatal injury.
 WARNING
Warns of a potentially hazardous situation which, if not avoided, could result in serious injury or death.
 CAUTION
Warns of an immediately hazardous situation which, if not avoided, can result in minor or moderate injury.
ATTENTION
Warns of an immediately hazardous situation which, if not avoided, can result in material or environmental damage.

INFORMATION

Indicates procedures in which there is **no** hazard of personal injury or material damage.

2.3 Product safety

The device reflects current engineering practice and accepted safety standards, but hazards can nonetheless arise.

Observe the safety regulations and warning notices. If notices are disregarded, this can lead to personal injury and/or damage to the product.

Every type of tampering with or use of this device, which goes beyond the mechanical, electrical or other operating limits can lead to personal injury and/or damage to the product;

- constitutes “misuse” and/or “negligence” under the product’s warranty and thus voids the warranty for any possible resulting damage.

Read and understand the user manual and, if applicable, the usage information before installing, operating, maintaining and using the device.

Only operate the device when in perfect condition and in compliance with this user manual and the usage information that is included. Send defective devices back to the manufacturer in compliance with proper transport conditions. Retain the user manual throughout the service life of the device and keep it at hand for consultation.

When using the device, also observe the legal and safety regulations for your system that are applicable for the respective use case.

2.4 Dangers when handling the device

When operating electric devices, it is unavoidable for certain parts of these devices to conduct hazardous voltage. Consequently, severe bodily injury or material damage can occur if they are not handled properly.

Therefore, when handling our devices, always observe the following:

- do not exceed the limit values specified in the user manual and on the rating plate! This must also be observed during testing and commissioning!
- Take note of the safety and warning notices in all usage information that belongs to the device!

WARNING

Disregarding the connection conditions of the Janitza measurement devices or their components can lead to injuries and even death or to material damage!

- Do not use Janitza measurement devices or components for critical switching, control or protection applications where the safety of persons and property depends on this function.
- Do not carry out switching operations with the Janitza measurement devices or components without prior inspection by your plant manager with specialist knowledge! In particular, the safety of persons, material assets and the applicable standards must be taken into account!

WARNING

Risk of injury due to electrical voltage!

Severe bodily injury or death can result! Therefore please abide by the following:

- Switch off your installation before commencing work! Secure it against being switched on! Check to be sure it is de-energized! Ground and short circuit! Cover or block off adjacent live parts!
- During operation and troubleshooting (especially for DIN rail devices), check your system for dangerous voltages and switch these off if necessary!
- Wear protective clothing and protective equipment in accordance with applicable guidelines when working on electrical systems!
- Before making connections to the device/the component, ground the device by means of the ground wire connection, if present.
- Do not touching bare or stripped leads that are energized! Equip stranded conductors with wire ferrules!
- Hazardous voltages can be present in all circuitry parts that are connected to the power supply.
- Protect wires, cables and devices with a suitable line circuit breaker/fuse!
- Never switch off, remove or tamper with safety devices!
- There can still be hazardous voltages present in the device or in the component even after it has been disconnected from the supply voltage (capacitor storage).
- Do not operate equipment with current transformer circuits when open.
- Only connect screw terminals with the same number of poles and design!
- Do not exceed the limit values specified in the user manual and on the rating plate! This must also be observed during testing and commissioning.
- Take note of the safety and warning notices in the documents that belong to the device!

2.5 Electrically qualified personnel

To avoid bodily injury and material damage, only electrically qualified personnel are permitted to work on the devices and their components, modules, assemblies, systems and current circuits who have knowledge of:

- The national and international accident prevention regulations.
- Safety technology standards.
- Installation, commissioning, operation, disconnection, grounding and marking of electrical equipment.
- The requirements concerning personal protective equipment.

Electrically qualified persons within the scope of the technical safety information of all usage information associated with the device and its components are persons who can furnish proof of qualification as an electrically skilled person.

 WARNING
<p>Warning against unauthorized manipulation or improper use of the device or its components! Opening, dismantling or unauthorized manipulation of the device and its components which goes beyond the mechanical, electrical or other operating limits indicated can lead to material damage or injury, up to and including death.</p> <ul style="list-style-type: none"> · Only electrically qualified personnel are permitted to work on the devices and their components, assemblies, systems and current circuits. · Always use your device or component only in the manner described in the associated documentation. · If there is discernible damage, send the device or the component back to the manufacturer!

2.6 Warranty in the event of damage

Any unauthorized tampering with or use of the device constitutes "misuse" and/or "negligence" under the product's warranty and thus voids the warranty for any possible resulting damage. In this regard, please take note of section „3.4 Intended use“ on page 17.

2.7 Safety information for handling current transformers and measurement devices with residual current measurement

 WARNING
<p>Risk of injury due to large currents and high electrical voltage on the current transformers! Current transformers operated while open on the secondary side (high voltage peaks pose a hazard when touched) can result in severe bodily injury or death.</p> <ul style="list-style-type: none"> · Avoid operating the current transformers while open; short circuit the unloaded transformers! · Before interrupting the current supply, short circuit the secondary connections of the current transformers. Switch any test switches that automatically short circuit the secondary lines of the current transformers to the "Test" status (Check the test switch/short circuiting connection beforehand)! · Only use current transformers with basic insulation to IEC 61010-1:2010! · Caution, even current transformers rated as safe for open operation can pose a hazard when touched during operation while open! · Make sure to mount screw terminals for the current transformer connection on the meter and, if necessary, fasten them with the enclosed screws! · Comply with the information and provisions in the documentation of your current transformers!

⚠ CAUTION**Risk of injury or damage to the meter due to high measurement currents at the connections of the current transformers!**

High measurement currents can cause temperatures of up to 80 °C (176 °F) on the connections of the current transformers

- Use wiring that is designed for an operating temperature of at least 80 °C (176 °F)!
- The current transformers can be hot even after the power supply has been switched off. Allow the connections of the current transformers and the connecting cables to cool down before touching them!

⚠ WARNING**Risk of injury or damage to the meter due to improper use!**

Meters with residual current measurement can trigger warning pulses if limit values are exceeded, and these are used exclusively for monitoring residual currents or failure monitoring. Use of the warning pulses as a stand-alone protective device against electrical shock can lead to injury and even death!

- Do not use devices with residual current measurement as a stand-alone protective device. Employ suitable protective devices for your system!

⚠ CAUTION**Risk of injury or damage to the meter/your system due to short circuit!**

Inadequate insulation of the operating equipment at the residual current measurement input with respect to the supply circuits can cause voltages at the measurement input which represent a hazard when touched or damage to your device or system.

- Ensure reinforced or double insulation with respect to the supply circuits!
- Ensure galvanic isolation of the residual current measurement inputs from each other!

2.8 Handling batteries/accumulators

The following apply for the battery used in the device:

⚠ CAUTION**Risk of injury due to fire or burns!**

The battery used in the device may cause fire or burns if used improperly.

- Only replace the battery with the same type or types recommended by Janitza!
- Observe the polarity when installing the battery!
- Remove batteries only with non-conductive tools (e.g. plastic tweezers)!
- Do not recharge, disassemble, burn or heat batteries above 100 °C (212 °F)!
- Do not dispose of batteries with household waste! Follow the disposal instructions in the respective device documentation!
- Keep batteries away from children and animals!
- In case of damage, return devices with a soldered battery to the manufacturer, observing proper transport conditions!

3. Product description

3.1 Device description

The measurement device is a multifunctional network analyzer and is suitable for:

- Measurements and calculations of electrical quantities such as voltage, current, power, energy, harmonics current in building installations, on distribution boards, circuit breakers and busbar trunking systems.
- Measurements of voltages and currents from the same network.
- Measurements in low-voltage networks in which nominal voltages of up to 417 V from conductors to ground and surge voltages of overvoltage category III occur.
- Measurements in medium and high voltage networks via current and voltage transformers. Measurements in medium and high voltage networks are made via current and voltage transformers!
- Current measurement via external low-power current transformers (small-signal current transformers according to IEC 61869-10) as well as Rogowski coils with or without an external integrator.
- The extension of the range of functions with modules (for the range of functions, see the user manual for the modules).

Measurement results are displayed by the measurement device and can be read and processed via interfaces.

3.2 Device versions

The measurement device is available in different versions for different grid systems (see section “6. Grid systems” on p. 24) and supply voltages.

The variant can be identified by means of the part number on the rating plate:

	Grid system, Supply	Part No. on rating plate
UMG 96-PQ-L-LP	TN / TT, 230 V	5236006
	TN / TT, 24 V	5236007

3.3 Incoming goods inspection

Safe and trouble-free operation of this device and its components presupposes proper transport, proper storage, set-up and assembly as well as operation and maintenance in addition to compliance with the safety information and warning notices.

Exercise due caution when unpacking and packing the device, do not use force and only use suitable tools.

Before installing the device, please check the following:

- Its flawless mechanical condition by visual inspection.
- The scope of delivery for completeness.

If it can be assumed that safe operation of the device is no longer possible:

- Disconnect the device from operation immediately!
- Secure the device against being switched on again!

It can be assumed that safe operation is no longer possible if the device, for example:

- Has visible damage.
- No longer functions despite an intact power supply.
- Was subjected to extended periods of unfavorable conditions (e.g. storage outside of the permissible climate thresholds without adjustment to the room climate, condensation, etc.) or transport stress (e.g. falling from an elevated position, even without visible external damage, etc.).

3.4 Intended use

The device is:

- Intended for use in residential and industrial areas.
- Intended for installation in stationary switchboard cabinets and small distribution boards, indoors or weather-protected.
- Not intended for installation in vehicles! Use of the device in non-stationary equipment constitutes an exceptional environmental condition and is only permissible by special agreement.
- Not intended for installation in environments with harmful oils, acids, gases, vapors, dusts, radiation, etc.
- Designed as an interior meter.

Safe and trouble-free operation of the device requires proper transport, storage, assembly, installation, operation and maintenance.

3.5 Performance characteristics

General

- Front panel installation device with dimensions of 96 x 96 mm (3.78 x 3.78 in).
- Expansion by means of module
- Connection via screw terminals
- Color graphic display 320 x 240 px
- Operation via 6 buttons
- 3 voltage measurement inputs (600 V, CAT III)
- 3 current measurement inputs (via current transformer)
- 3 digital outputs
- 3 digital inputs (configured as pulse counter with simultaneous power calculation)
- 1 analog output (0 - 20 mA)
- Data memory 64 MByte flash
- RS-485 interface (Modbus RTU, slave, up to 115 kbps)
- Clock and battery
- Working temperature range -10 °C (14 °F) to +55 °C (131 °F).

Measurement

- Acquisition of more than 800 measured values
- Measurement in TN and TT networks
- Measurement in networks with nominal voltages up to L-L 720 V_{rms} and L-N 417 V_{rms} (according to IEC)
- True effective value measurement (TRMS)
- Continuous sampling of the voltage and current measurement inputs
- Frequency range of the fundamental oscillation 45 Hz .. 65 Hz
- Measurement of harmonics current, 1st to 65th for U_{LN} and I1 to I3
- U_{LN}, U_{LL}, I, P (consumption/delivered), Q (ind./cap.)
- 2 tariffs (switching via Modbus or digital input 1)

Measuring accuracy and range

- Active energy: Measurement uncertainty class 0.5 for low-power current transformers and Rogowski coils
- Reactive energy: Class 1
- Measuring range current: up to 400 mV (setting *Low power*) up to 800 mV (setting *Rogowski*)

3.6 EU conformity declaration

Please see the EU declaration of conformity posted at www.janitza.com for the laws, standards and directives applied by Janitza electronics GmbH for the devices. The CE conformity marking requirements for the device arise from the EU conformity declaration and the laws, standards and directives mentioned therein.

3.7 Scope of delivery

Quantity	Part. no.	Designation
1	5236xxx ¹⁾	UMG 96-PQ-L-LP
1	3303890	Installation manual
1	3303342	"Safety Information" supplement
1	3303361	"GridVis Software" Quick Guide
1	5236252	UMG 96-PQ-L-LP accessory pack

1) For part number see delivery note
Tab. Scope of delivery

3.8 Accessories

Quantity	Part. no.	Designation
1	2101058	Battery type, lithium CR2032, 3 V (approval according to UL 1642)
1	2901065	Silicone seal, 96 x 96
1	1506015	Interface converter RS-485 <-> RS-232
1	1506107	Interface converter RS-485 <-> USB

Suitable current transformers (examples):

Quantity	Part. no.	Designation
1	1503334	CT-SC-006-20 20 A/333 mV, Cl. 0.5
1	1503335	CT-SC-010-50 50 A/333 mV, Cl. 0.5
1	1503345	CT-040-100 100 A/333 mV, Cl. 0.5
1	1503346	CT-040-250, 250 A/333 mV, Cl. 0.5
1	1503349	CT-BSC-120-2500, 2500 A/333 mV, Cl. 0.5
1	1503635	Rogowski coil Ø 120 mm, 1000 A/100 mV, ±1%

A current overview of suitable current transformers can be found at www.janitza.com.

INFORMATION

All supplied options and design variants are described on the delivery note.

3.9 Measuring method

The device measures

- Continuously and calculates all effective values using in a 200 ms interval.
- The true RMS value (TRMS) of the voltages and currents applied to the measurement inputs.

3.10 Transformers

Only use "current transformers for measuring purposes" (small-signal measuring transformers) for Janitza measurement devices and components!

3.11 Operating concept

The operating concept of the measurement device incorporates the following methods:

- 6 function buttons with display for configuration and acquisition of data.
- The GridVis network analysis and programming software® for programming and analysis of data.
- The Modbus protocol and the Modbus address list to configure and read out data. The Modbus address list is available at www.janitza.com.

This user manual describes how to operate the measurement device using the 6 function buttons and how to use the Modbus editor.

3.12 GridVis® network analysis software

The GridVis® software (download at www.janitza.com) is the perfect tool for the configuration, readout and analysis of measurement data.

Performance characteristics of the GridVis® software

- Configure and read out data from your measurement device.
- Graphic display of measured values.
- Store measurement data in databases.
- Analyze measurement data that has been read out.
- Create reports.

Connections to the PC (GridVis® software)

Connections for communication between the PC and the measurement device can be found in section „8. Connection and PC connections“ on page 34.

4. Structure of the device

4.1 Front panel - Display and controls

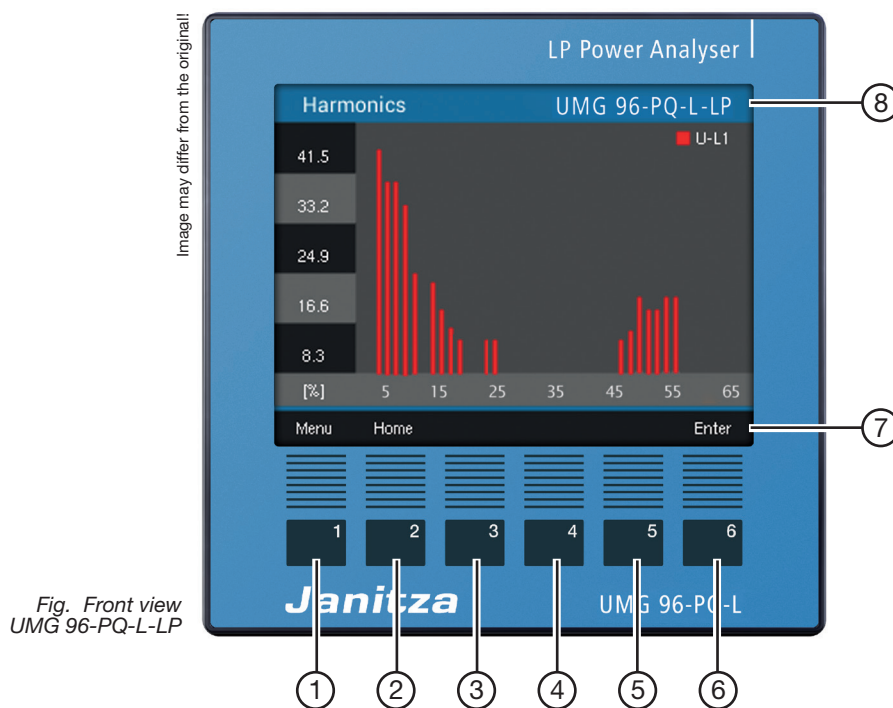

Fig. Front view UMG 96-PQ-L-LP

Item	Function/Designation
1	Button 1: · Display Menu · Exit Menu · Cancel action (ESC)
2	Button 2: · Go to the start screen. (Default setting: "Overview" display) · Select position (to the left "◀"). · Configuration of a measuring display as the start screen (press until message appears).
3	Button 3: · Select menu item or position (down "▼"). · Change (selection, number -1).
4	Button 4: · Select menu item or position (up "▲"). · Change (selection, number +1).
5	Button 5: · Select position (to the right "▶").
6	Button 6: · Open selection menu, activate input, confirm selection (Enter).
7	Description of the function buttons
8	Device name, can be changed by customer

Tab. Front panel - Display and controls

4.2 Rear of the device - Connections

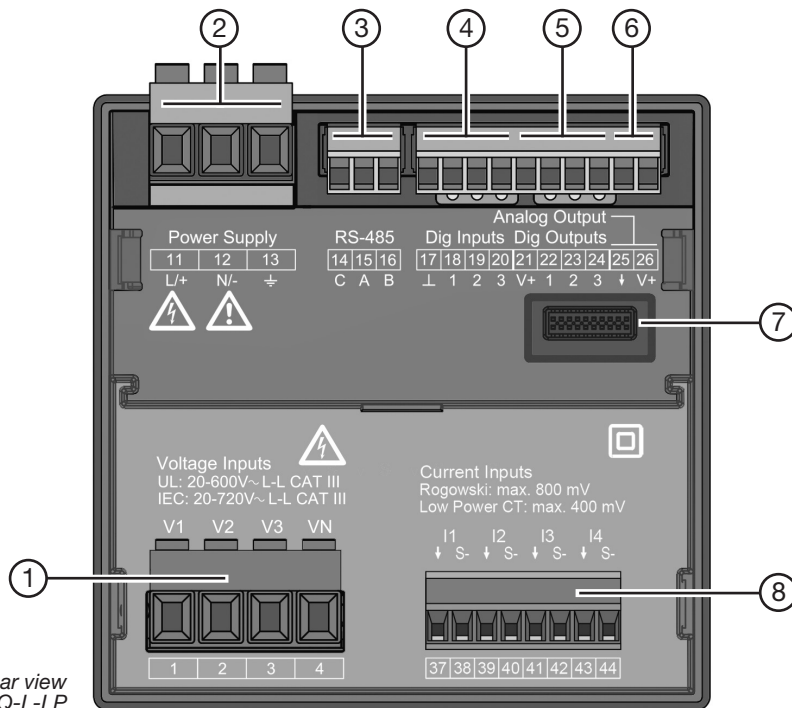

Fig. Rear view
UMG 96-PQ-L-LP

Item	Function/Designation
1	Voltage measurement inputs V ₁ to V ₃ and V _N
2	Supply voltage
3	RS-485 interface
4	Digital inputs
5	Digital outputs
6	Analog outputs
7	Module connector socket
8	Current measurement inputs I ₁ to I ₄ (8-pole)

Tab. Rear of the device - Connections

4.3 Rating plate



Item	Designation	Description
1	Operational data	<ul style="list-style-type: none"> · Supply voltage, AC in V · Nominal frequency in Hz · Supply voltage, DC in V · Power consumption in VA · Overvoltage category
2	Part number	Manufacturer's part number
3	Symbol for "Danger sign"	General hazard symbol. Be certain to observe the warning notices applied to the device and shown in the documentation in order to avoid possible injury or even death.
4	Device type	Device designation
5	Data matrix code	Coded manufacturer data
6	Manufacturer's logo	Logo of the device manufacturer
7	CE conformity marking	See section „3.6 EU conformity declaration“ on page 18.
8	Manufacturer-specific data	Manufacturer data
9	Hardware version	Hardware version of your device
10	Type/serial number	Number for identification of the device
11	Designation of origin/web address	Country of origin and manufacturer's web address

Tab. Rating plate

5. Mounting

5.1 Installation location

! DANGER

Danger of electric shock!

Electric shocks lead to serious injuries, including death.

- Disconnect your system from the power supply before mounting and connecting the device!
- Secure it against being switched on!
- Check to be sure it is de-energized!
- Ground and short circuit!
- Cover or block off adjacent live parts!
- The installation must only be carried out by qualified personnel with electrical training!

The measurement device is suitable for installation in stationary and weather-protected indoor switchboards. Ground conductive switchboards!

ATTENTION

Material damage due to disregard of the installation instructions!

Failure to observe the installation instructions can damage or destroy your device.

- **Observe the information on the mounting orientation in the sections "Mounting" and "Technical Data".**
- **Provide adequate air circulation in your installation environment and, as needed, cooling when the temperatures are high!**

5.2 Mounting orientation

The mounting orientation is arbitrary. The cut-out dimensions in the switchboard are $92^{+0.8}$ mm x $92^{+0.8}$ mm ($3.62^{+0.03}$ in x $3.62^{+0.03}$ in).

Minimum clearances for adequate ventilation:

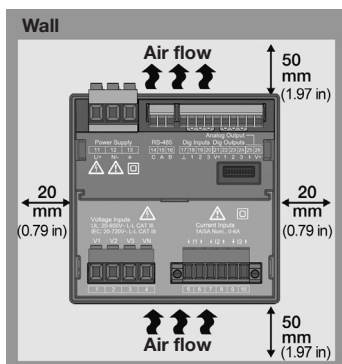

Fig. Mounting orientation of the meter (rear view)

5.3 Securing

Secure the device inside the switchboard (mounting plate) with the fastening clips on the side. To do so, proceed as follows:

- Before inserting the device, remove the fastening clips (e.g. with a screwdriver) by levering them horizontally.

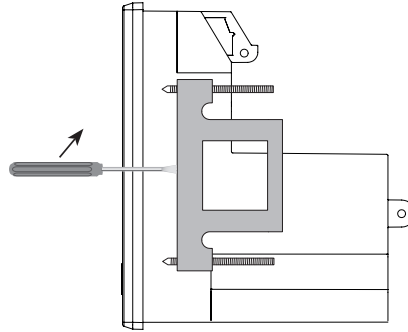

Fig. Side view of the measurement device with fastening clip.

- Guide the device through the switchboard (mounting plate) from the front.
- Attach the clips to the side of the device by pushing them in and snapping them into place.
- Screw in the clamping screws until they touch the mounting plate.
- Then tighten the clamping screws with two further turns each. **Too tightly tightened clamping screws can destroy the fastening clips!**

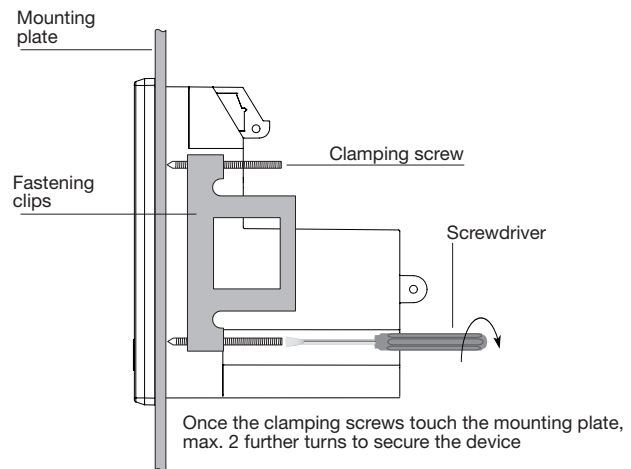
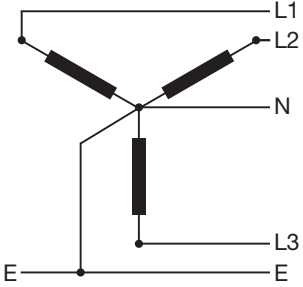
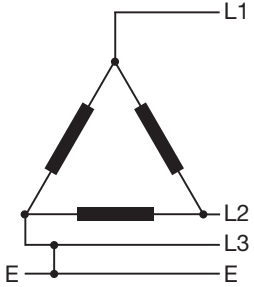

Fig. Fastening process

6. Grid systems

Grid systems and maximum rated voltages according to DIN EN 61010-1/A1:

TN network		TT network	
<p>Three-phase 4-conductor systems with grounded neutral conductor</p> 		<p>Three-phase 3-conductor systems with grounded phase</p> 	
IEC	$U_{L-N} / U_{L-L}: 417 V_{LN} / 720 V_{LL}$	IEC	$U_{L-L}: 600 V_{LL}$
UL	$U_{L-N} / U_{L-L}: 347 V_{LN} / 600 V_{LL}$	UL	$U_{L-L}: 600 V_{LL}$

WARNING

Risk of injury due to electrical voltage!

Rated surge voltages above the permitted over-voltage category can damage the insulation in the device. This impairs the safety of the device. This can result in serious injury or death.

- Only use the device in environments which comply with the permissible rated surge voltage.
- Observe the limit values specified in the user manual and on the rating plate.

The measurement device can be used in:

- TN and TT networks.
- Residential and industrial areas.

INFORMATION

The variant of the **measurement device can be recognized by the part number**. The part number can be found on the rating plate of your measurement device:

- UMG 96-PQ-L-LP: 52360x6/52360x7

7. Installation

Use the measurement device for voltage measurement in TN and TT grid systems with the approved overvoltage category of 600 V CAT III or 300 V CAT IV (rated surge voltage 6 kV).

WARNING

Disregard of the connection conditions of the transformers to Janitza measurement devices or their components can lead to injuries or even death or to material damage!

- Do not use the outputs of the Janitza measurement devices or their components for switching protective devices or protective relays! Do not use "Transformers for protection purposes"!
- For Janitza measurement devices and their components use only "Transformers for measurement purposes" which are suitable for the energy monitoring of your system.
- Observe the information, regulations and limit values in the usage information on "Transformers for measuring purposes", including during testing and commissioning of the Janitza measurement device, the Janitza component and your system.

CAUTION

Malfunction and damage of the device or risk of injury due to improper connection.

Improperly connected devices can deliver incorrect measured values, damage the device or pose a risk of injury to persons.

Observe the following:

- Measured voltages and currents must originate from the same network.
- Do not use the measurement device for measuring direct current!
- Ground current-conducting switchboards!

7.1 Nominal voltages

7.1.1 Three-phase four-conductor network with grounded neutral conductor

Networks and nominal voltages suitable for your measurement device:

U_{L-N} / U_{L-L}	
66 V / 115 V	
120 V / 208 V	
127 V / 220 V	
220 V / 380 V	
230 V / 400 V	
240 V / 415 V	
260 V / 440 V	
277 V / 480 V	
347 V / 600 V	Maximum nominal voltage of the network according to UL
400 V / 690 V	
417 V / 720 V	Maximum nominal voltage of the network according to IEC

Fig. Nominal network voltages suitable for measurement inputs according to EN 60664-1:2003 (valid in three-phase 4-conductor systems with grounded neutral conductor - see section "Grid systems").

INFORMATION

The device optionally allows the connection of 100 V voltage transformers!

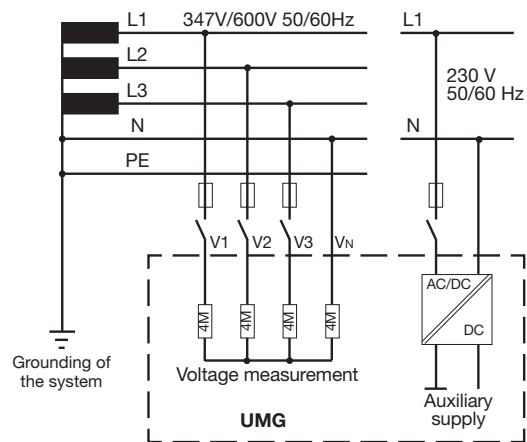

Fig. Example, schematic diagram (UMG 96-PQ-L) - Measurement in three-phase 4-conductor systems.

7.3.1 Three-phase three-conductor system

Networks and nominal voltages suitable for your device:

U_{L-L}
100 V
120 V
200 V
240 V
347 V
380 V
400 V
415 V
440 V
480 V
600 V

Maximum nominal voltage of the network according to IEC and UL

Fig. Nominal network voltages suitable for measurement inputs according to EN 60664-1:2003 (valid in three-phase 3-conductor systems - see section "Grid systems").

7.2 Circuit breaker

Install a suitable circuit breaker for the supply voltage in the building installation in order to disconnect the device from voltage and current.

- Install the circuit breaker near the device and within reach of the user.
- Mark the circuit breaker as the isolation device for this piece of equipment.

7.3 Supply voltage

WARNING

Risk of injury due to electrical voltage!

Severe bodily injury or death can result from:

- Touching bare or stripped leads that are energized.
- Device inputs that pose a hazard when touched.
- Disconnect your system from the power supply before mounting and connecting the device!
- Secure it against being switched on!
- Check to be sure it is de-energized!
- Ground and short circuit!
- Cover or block off adjacent live parts!

Operation of the device requires a supply voltage.

The type and level of the supply voltage for your device can be found on the rating plate. Also note:

- Before applying the supply voltage, ensure that the voltage and frequency match the specifications on the rating plate.
- Connect the supply voltage via a UL/IEC approved fuse to the plug-in terminals on the rear of the device.
- After connecting the supply voltage, the display appears.

INFORMATION

Note that the device requires an initialization phase (boot time) at startup!

If no display appears, check:

- The connection of your device.
- The supply voltage.

⚠ WARNING

Risk of injury due to electrical voltage!

Severe bodily injury or death can result from:

- Touching bare or stripped leads that are energized.
- Device inputs that pose a hazard when touched.

Switch off your installation before commencing work! Secure it against being switched on! Check to be sure it is de-energized! Ground and short circuit! Cover or block off adjacent live parts!

⚠ CAUTION

Material damage due to disregard of the connection instructions!

Disregard of the connection instructions can damage or destroy your device.

Therefore please abide by the following:

- Observe the voltage and frequency specifications on the rating plate!
- Connect the supply voltage via a fuse according to the technical data!
- Do not tap the supply voltage from the voltage transformers!
- Provide a fuse for the neutral conductor if the neutral conductor terminal of the source is not grounded!

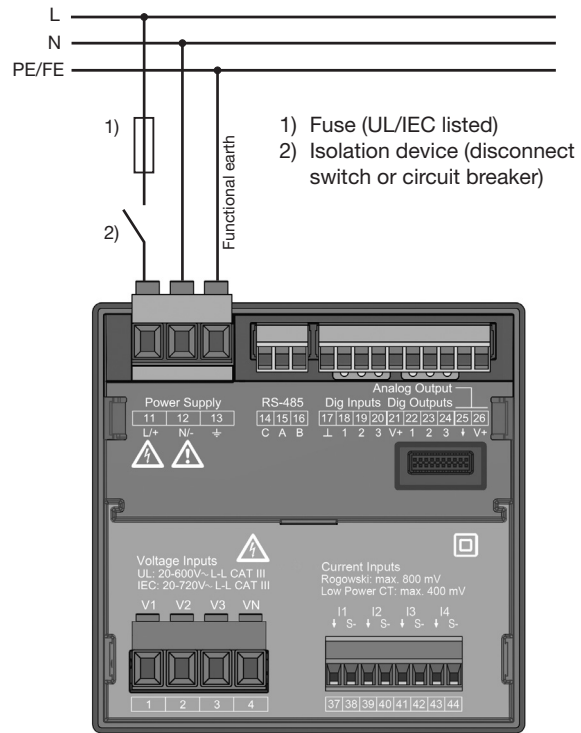

Fig. "Supply voltage" connection example

ⓘ INFORMATION

Without a functional earth, the device indicates a residual voltage that is not applied.

Overcurrent protective device for the line protection of the supply voltage

Recommendation for the overcurrent protective device of the supply voltage line protection (dependent on the device variants):

- Option 230 V --> 6 - 16 A (Char. B)
- Option 24 V * --> 1 - 6 A (Char. B)

ⓘ INFORMATION

The fuse is a line protection, **not** a device protection!

7.4 Voltage measurement

There are 3 voltage measurement inputs (V1 to V3) on the rear of the device.

7.4.1 Overvoltage

The voltage measurement inputs are suitable for measurement in networks where overvoltages of category 600 V CAT III (rated surge voltage 6 kV) can occur.

7.4.2 Frequency

The device:

- Requires the mains frequency for the measurement and calculation of measured values.
- Is suitable for measurement in networks in which the fundamental oscillation of the voltage is in the range from 45 Hz to 65 Hz.

The mains frequency is determined from the measured voltage of phase L1. The sampling frequency of the voltage and current measurement inputs results from the mains frequency.

When measuring with strongly distorted voltages, the frequency of the voltage fundamental oscillation can no longer be determined exactly. This means that for strongly distorted measured voltages, the corresponding mains frequency should have a fixed specification. Voltage distortions occur, for example, during measurements on consumers that are operated with phase-angle control. Distortions of the current do not influence the frequency determination.

Further information can be found in the chapter „12.4.5 Nominal frequency“ on page 50.

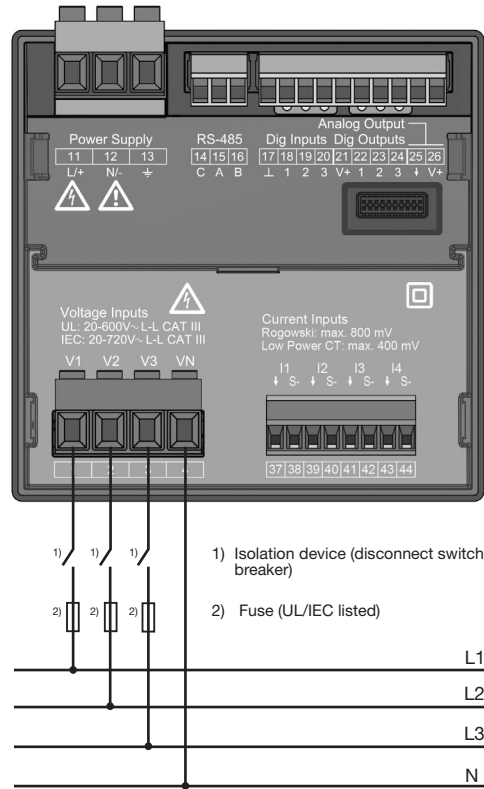

Fig. Connection example for voltage measurement.

⚠ WARNING

Risk of injury due to electrical voltage!
 Serious bodily injury or death can result from failure to observe the connection conditions for the voltage measurement inputs.
Therefore please abide by the following:

- Switch off your installation before commencing work! Check to be sure it is de-energized!
- Connect voltages above the permitted nominal network voltages via voltage transformers.
- The voltage measurement inputs on the device are dangerous to touch!
- Install a circuit breaker (see section Sect. 7.2 on page 26).
- Use a UL/IEC approved overcurrent protective device with a nominal value rated for the short circuit current at the connection point.

i INFORMATION

- The device only determines measured values if a voltage L1-N of greater than 20 V_{eff} (4-conductor measurement) or a voltage L1-L2 of greater than 34 V_{eff} (3-conductor measurement) is applied to voltage measurement input V1.
- Use a line protection (1-10 A) with IEC/UL approval as an overcurrent protective device for voltage measurement.

7.4.3 Connection variants for voltage measurement

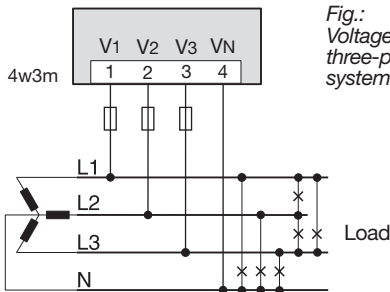

Fig.: Voltage measurement in three-phase 4-conductor system

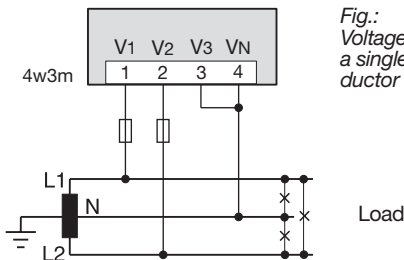

Fig.: Voltage measurement in a single-phase 3-conductor system.

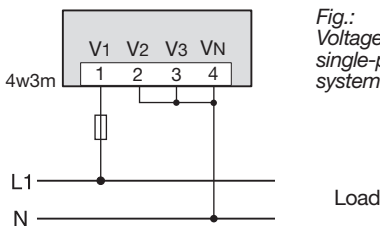

Fig.: Voltage measurement in a single-phase 2-conductor system.

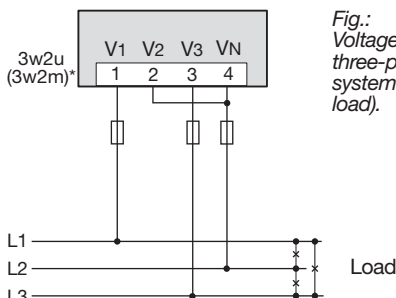

Fig.: Voltage measurement in a three-phase 3-conductor system (asymmetrical load).

* Setting 3w2u or 3w2m depending on the connection of the current measurement.

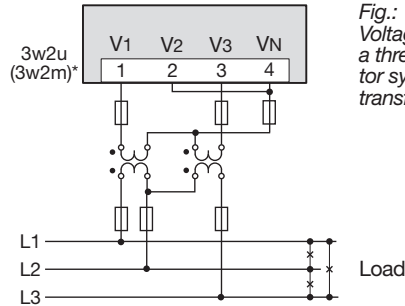

Fig.: Voltage measurement in a three-phase 3-conductor system with voltage transformer.

* Setting 3w2u or 3w2m depending on the connection of the current measurement.

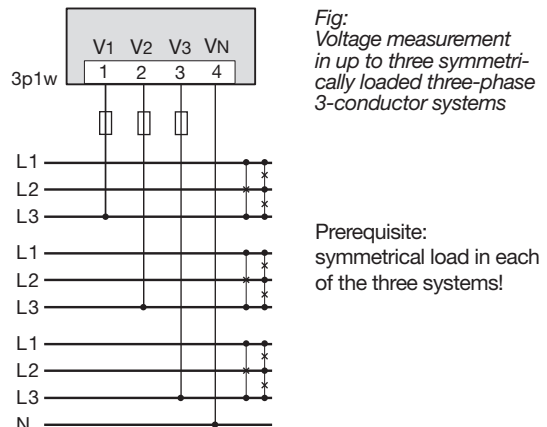

Fig.: Voltage measurement in up to three symmetrically loaded three-phase 3-conductor systems

Prerequisite: symmetrical load in each of the three systems!

One of the 3 neutral conductors must be connected.

Use the measurement device only in TN and TT networks.

CAUTION

Malfunction due to improper connection. Improper connection of the device can result in incorrect measured values.
Therefore please abide by the following:

- Measured voltages and currents must originate from the same network.
- The device is not suitable for measuring DC voltage.

Recommendation: Short-circuit unused voltage measurement inputs to the V_N input.

Connection variant "Voltage measurement with functional earthing (FE)"

For a measurement in a grounded 3-phase system without N, connect the PE as a functional earth (FE) to the voltage measurement input V_N of the device. Make sure to use the color "pink" (DIN EN 60445/VDE 0197) for the functional earth conductor and to observe the limits for the voltage measurement.

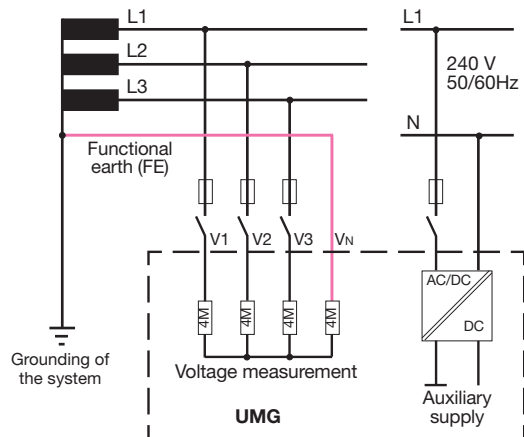

Fig. Connection variant - Voltage measurement in a grounded 3-phase system.

Do not use the protective earthing present in your system as functional a earthing!

7.4.4 Voltage transformers

The following applies when using voltage transformers:

! WARNING

Risk of injury due to electrical voltage!

Do not short-circuit secondary connections of voltage transformers! This can result in serious injury or death.

- Connect voltage transformers according to their documentation!
- Check your installation!

The device only allows the setting of **one voltage transformer ratio** for **all phases!**

i INFORMATION

The **voltage transformer ratios** can be conveniently configured via:

- The device menu.
- The GridVis® software.

For information on voltage transformer configuration, see the section „12.4.1 Current and voltage transformers“ on page 46.

For information on overrange, see the section „13.7 Overrange“ on page 63.

7.5 Current measurement with low-power current transformers

The measurement device has four inputs for current measurement. Only the following current sensors can be used:

Current sensor type	Current sensor requirement
<ul style="list-style-type: none"> Low-power current transformers (passive small-signal current transformers according to IEC 61869-10) Active Rogowski coils (with integrator) 	Nominal signal e.g. 333 mVrms, (max. 400 mVrms) Setting: <i>Low Power</i>
<ul style="list-style-type: none"> Passive Rogowski coils (integrator in the UMG 96-PQ-L-LP must be activated) 	Transformer ratio e.g. 100 mV/kA (or 333 mV/kA) Setting: <i>Rogowski</i>

- Wire the current sensors directly to the measurement device. Short-circuit terminals as with inductive current transformers are not required.
- The pre-assembled connecting cables are matched to the current sensors. The cable length should not be changed (recommendation: max. 5 m), as this can influence the measurement result.

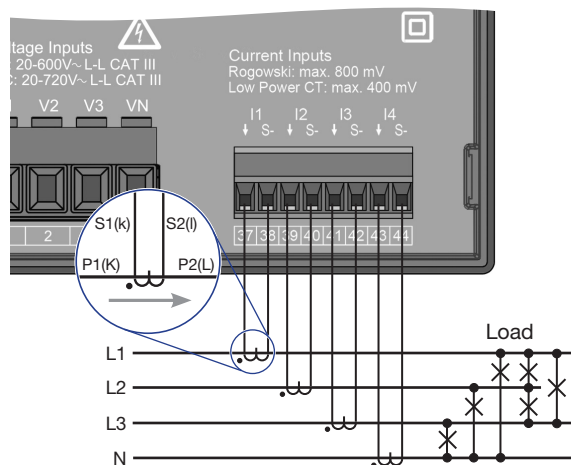

Fig. Connection example for LP current measurement.

The I4 current measurement input (terminals 43/44) can be used to measure the RMS current in the neutral conductor, protective conductor, or in a separate conductor. The measured current is not used to calculate power and energy values. The I4 current can be monitored by a comparator, e.g. to record an event or to switch a digital output when a threshold is exceeded (see „13.14.7 Comparator“ on page 73).

The device does not measure direct currents.

! WARNING

Risk of injury due to electrical voltage!
 Severe bodily injury or death can result from:

- Touching bare or stripped leads that are energized.
- Device inputs that pose a hazard when touched.

Disconnect your system from the power supply before starting work! Check to be sure there is no voltage! Ground the system!
Use the ground connection points with the ground symbol to do so!

i INFORMATION

All types of low-power current sensors can be operated **exposed on the secondary side**. In technical terms, no dangerously high voltages can occur. Inductive current transformers with secondary currents of ..1 A or ..5 A must not be used!

i INFORMATION

With Rogowski coils, the output signal is 90° out of phase with the measured current. The integrator circuit corrects this phase shift.

- Active Rogowski coils have a separate power supply for the external integrator circuit.
- For passive Rogowski coils without their own power supply, activate the integrator circuit in the measurement device (setting *Rogowski*, see section „12.4.2 Current sensor type“ on page 47).
- The transformer ratio of Rogowski coils depends on the mains frequency of 50 or 60 Hz (see manufacturer's data sheet).

The factory-set current transformer ratio must be adapted to suit the current transformers used (see section „12.4.1 Current and voltage transformers“ on page 46).

7.5.1 Connection variants for current measurement

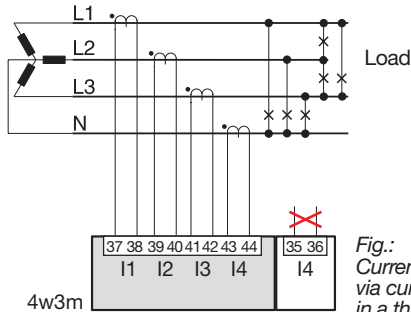

Fig.: Current measurement via current transformer in a three-phase 4-conductor system

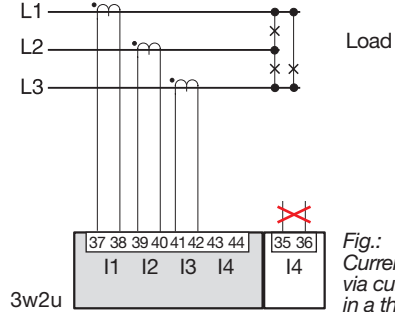

Fig.: Current measurement via current transformer in a three-phase 3-conductor system

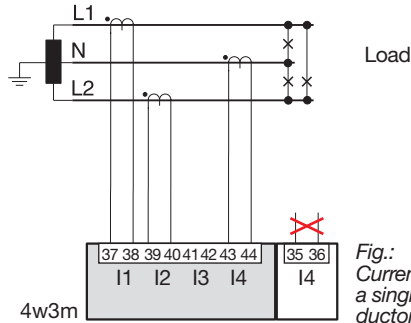
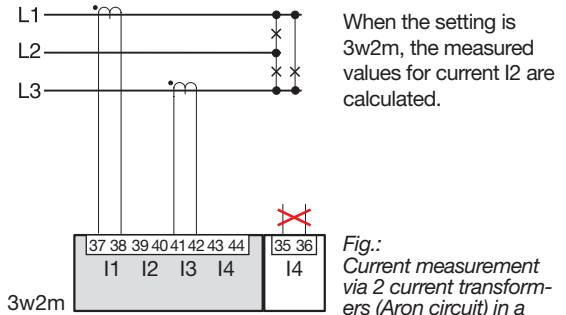

Fig.: Current measurement in a single-phase 3-conductor system



When the setting is 3w2m, the measured values for current I2 are calculated.

Fig.: Current measurement via 2 current transformers (Aron circuit) in a three-phase 3-conductor system

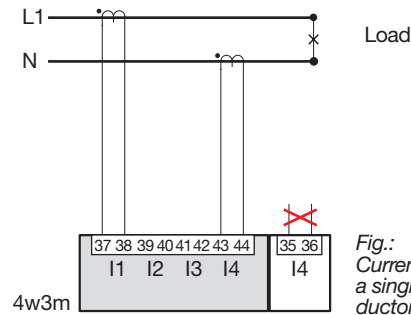
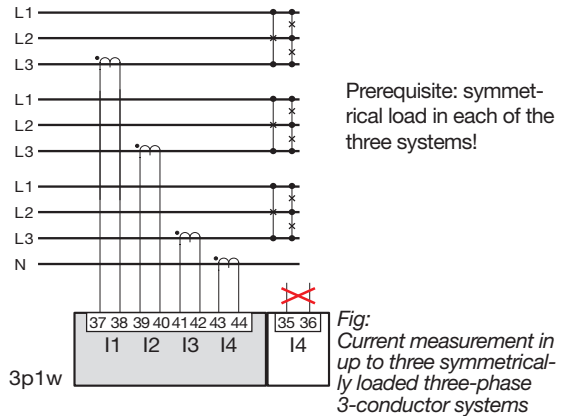

Fig.: Current measurement in a single-phase 2-conductor system



Prerequisite: symmetrical load in each of the three systems!

Fig.: Current measurement in up to three symmetrical loaded three-phase 3-conductor systems

i INFORMATION

You must set the selected connection variant (e.g. 4w3m) in the device so that power and energy are calculated correctly (see section „12.4.4 Connection variant“ on page 48).

i INFORMATION

Current I4 is always measured via terminals 43 and 44 on the UMG 96-PQ-L-LP.

If a 96-PA-RCM(-EL) module is installed, terminals 35/36 of the module have no function!

 INFORMATION

The device only allows **one current transformer ratio** to be set for **the phases L1..L3!**

You can configure **current transformer ratios** conveniently via

- The device menu.
- The GridVis® software.

For information on current transformer configuration, see the chapter „12.4.1 Current and voltage transformers“ on page 46.

 INFORMATION

If the measuring range is exceeded, the device display shows the warning **Range exceeded** with specification of the current or voltage circuit.

For information on overrange, see the section „13.7 Overrange“ on page 63.

7.5.2 Current direction

You can correct the current direction for each phase individually via the serial interfaces provided. This means that in the case of incorrect connection, no subsequent reconnection of the current transformers is necessary.

8. Connection and PC connections

8.1 Connection variants

When connecting the device to a PC, there are several possibilities:

1. Connection via an interface converter of the type RS-232/RS-485 or USB/RS-485:

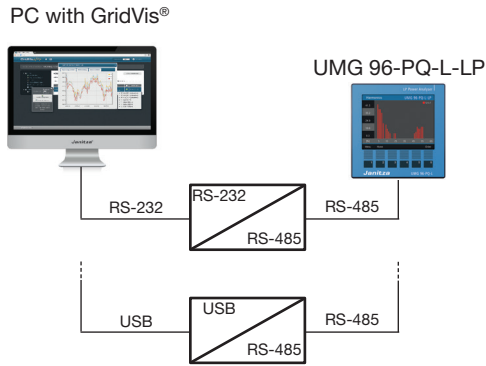

2. Connection of the UMG 96-PQ-L-LP (basic device) via a UMG with gateway functionality:

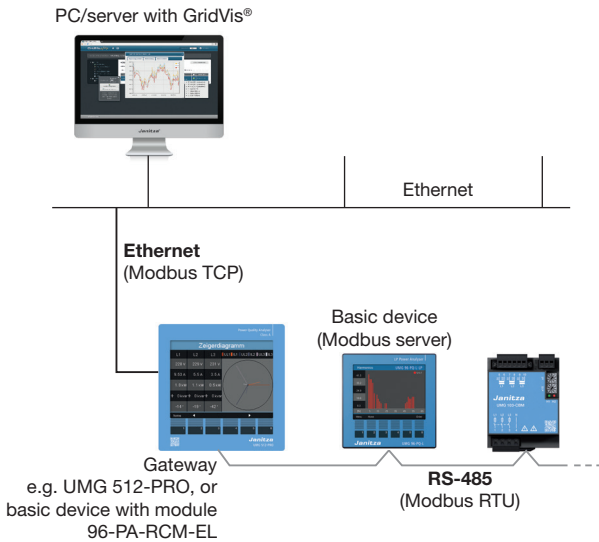

The gateway acts as a Modbus TCP server and as a Modbus RTU client.

i INFORMATION

- As an option to these connection options, an expansion module for the measurement device provides an Ethernet interface for communication.
- Information on the Expansion module with Ethernet interface can be found in the usage information on the module 96-PA-RCM-EL.

i INFORMATION

New terms of the Modbus organization!

- The **Modbus organization (modbus.org)** uses the terms "**client**" and "**server**" as a substitute for "master" and "slave".
- The client device initiates the communication and sends requests via Modbus.
- The server devices process the requests and return appropriate responses.

! CAUTION

Material damage due to incorrect network settings.

Incorrect network settings can cause faults in the IT network.

Ask your network administrator about the correct network settings for your device.

8.2 RS-485 interface

The device communicates with the Modbus RTU protocol via an RS-485 interface (3-pole plug contact).

Recommended cable type:

- **Unitronic Li2YCY(TP) 2x2x0.22 (Lapp cable)**

Connection capacity of the terminal:

- 0.2 - 1.5 mm²
(see the section "Technical Data")

i INFORMATION

- CAT cables are not suitable for bus wiring! Use the recommended cable types (see above).
- A segment of an RS-485 bus structure contains up to 32 nodes/devices. Connect more than 32 nodes/devices with repeaters.
- The device does not contain an integrated termination resistor (see chapter „8.4 Termination resistors“ on page 37).
- In an RS-485 bus structure, please observe the address settings for your server and client devices in the respective documentation.

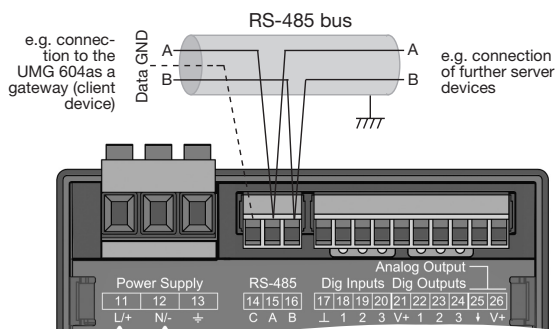

Fig. RS-485 interface, 3-pole plug contact

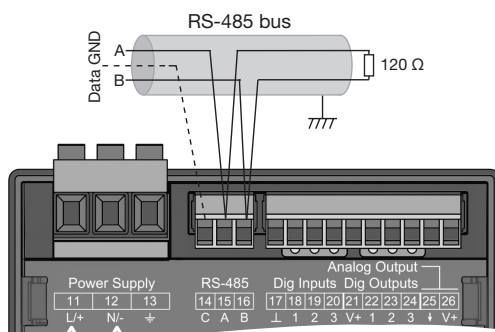

Fig. RS-485 interface, 3-pole plug contact with termination resistor (part no. 5200008)

8.3 Shielding

Provide a twisted and shielded cable for connections via the interfaces and observe the following points for shielding:

- Ground the shields of all cables leading into the cabinet at the cabinet entrance.
- Connect the shield to a noiseless ground and ensure a large surface area with good conductivity.
- Do **NOT** connect the shield to terminal C (GND)
- Mechanically restrain the cables before the grounding clamp to prevent damage from cable movement.
- Use suitable cable glands, for example PG glands, to lead the cable into the switchboard cabinet.

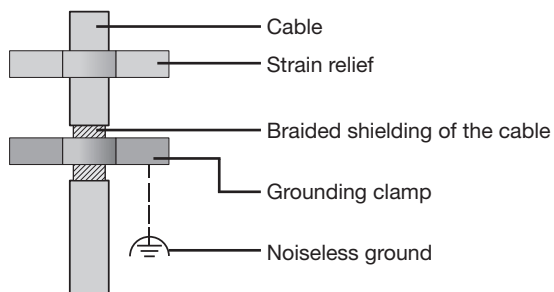

Fig. Shielding design for cabinet entry.

! WARNING

Transmission error and risk of injury due to electrical fault!

Atmospheric discharge can cause transmission errors and hazardous voltages on the device.

Therefore please abide by the following:

- **Connect the shielding to functional earth (PE) at least once.**
- **In the case of larger sources of interference, frequency converters in the switchboard cabinet, connect the shielding to functional earth (PE) as close as possible to the device.**
- **Observe the maximum cable length of 1200 m (3936 ft.) at a baud rate of 38.4 k.**
- **Use shielded cables.**
- **Route interface cables spatially separated or additionally insulated from mains voltage-carrying system components.**



8.4 Termination resistors

At the beginning and end of a segment, the cable is to be terminated with resistors (120 Ω, 1/4 W).

i INFORMATION

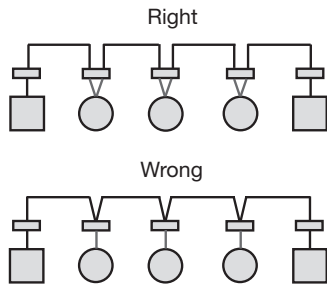
The device does not contain an integrated termination resistor!



-  Terminal strip in the switchboard cabinet.
-  Device with RS-485 interface. (Without termination resistor)
-  Device with RS-485 interface. (With termination resistor on the device)

8.5 Bus structure

In a bus structure:

- Connect all devices in line.
- Each device has its own address.
- One segment contains up to 32 nodes/devices. At the beginning and end of a segment, the cable must be terminated with resistors (bus termination, 120 ohms, 1/4 W)!
- With more than 32 participants, use repeaters (line amplifiers) to connect segments!
- Devices with bus termination switched on must be powered.
- It is recommended that the client device be placed at the end of a segment. If the server device is replaced with the bus termination switched on, the bus is out of operation.
- The bus can become unstable if a server device with bus termination switched on is replaced or is de-energized.
- Devices that are not involved in the bus termination can be replaced without the bus becoming unstable.

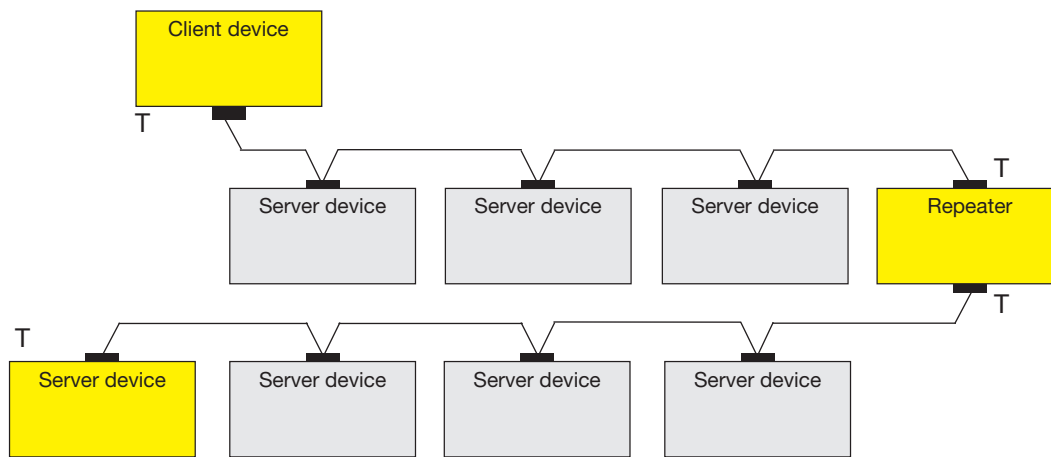

 Power supply necessary

T Bus terminator on

Client device - e.g. UMG 604-PRO

Server device - UMG 96-PA/PQ series

Fig. Representation of a bus structure *

* In a **Modbus system**, the Modbus organization (modbus.org) uses the terms "client" and "server" to describe Modbus communication. This is characterized by communication between client devices - formerly master devices - that initiate communication and make requests, and server devices - formerly slave devices - that process the requests and return an appropriate response (or error message).

9. Digital inputs and outputs

The device has:

- 3 digital inputs and
- 3 digital outputs

9.1 Digital inputs

The device has 3 digital inputs for the connection of, for example, one signal generator each. If a signal is present, the corresponding LED lights up green.

The device recognizes an input signal at the digital input if:

- A voltage of at least 18 V and at most 28 V DC (typically at 4 mA) is present.
- A current of at least 0.5 mA and at most 6 mA flows.

Observe the polarity of the supply voltage!

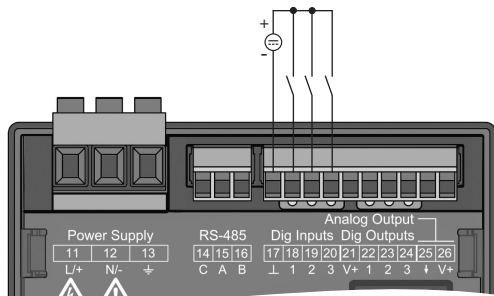

Fig. Connection of the digital inputs

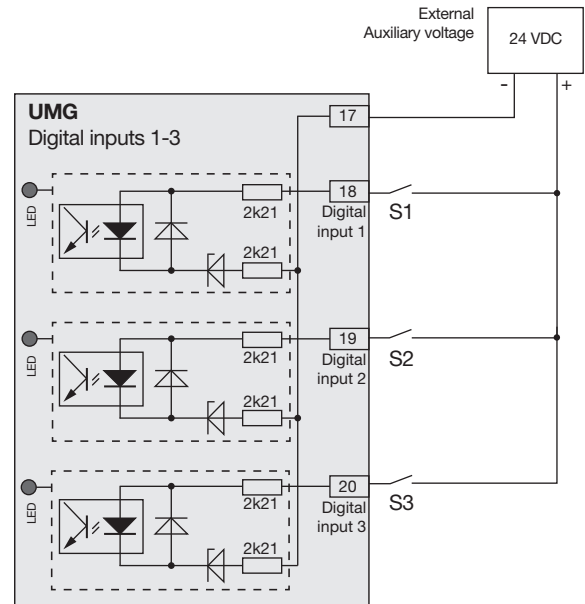

Fig. Example for the connection of the external switching contacts S1-S3 to the digital inputs 1, 2 and 3.

9.1.1 S0 pulse input

Each digital input is designed for the connection of an S0 pulse generator according to DIN EN62053-31.

You need an external auxiliary voltage with an output voltage in the range of 18 .. 28 VDC and a resistance of 1.5 kOhms.

⚠ CAUTION

Transmission error and material damage due to electrical malfunction.

With a cable length of more than 30 m (32.81 yd), there is an increased probability of transmission errors and damage to the device due to atmospheric discharge!

Use shielded cables for the connections to the digital inputs and outputs!

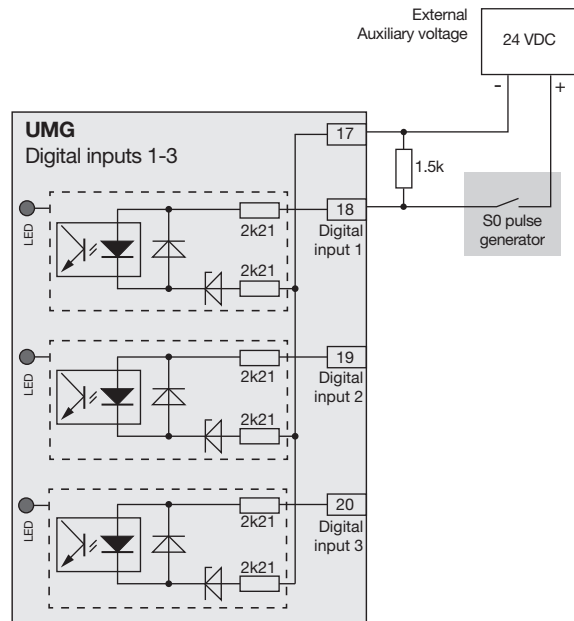

Fig. Example for the connection of an S0 pulse generator to digital input 1.

9.2 Digital outputs

The measurement device has 3 digital outputs, which:

- Are electrically isolated from the evaluation electronics via optocouplers.
- Have a common reference.
- Are **not** short-circuit proof.
- Require an external auxiliary voltage.
- Can be used as impulse outputs.
- Are able to switch direct and alternating current loads.
- Can be controlled via Modbus.
- Output the results of comparators.

⚠ CAUTION

Material damage due to connection errors.
The digital outputs are not short-circuit proof! Connection errors can therefore lead to damage to the connections.
Make sure that the wiring is correct when connecting the outputs.

i INFORMATION

- Functions for the digital outputs can be configured easily and clearly in the GridVis® software (see www.janitza.com).
- Use of the GridVis® software requires a connection between the device and the PC via an interface.

⚠ CAUTION

Measurement error when used as a pulse output.
When the digital outputs are used as pulse outputs, measurement errors can occur due to residual ripple.
For the supply voltage (DC) of the digital inputs and outputs, use a power supply whose residual ripple is less than 5% of the supply voltage.

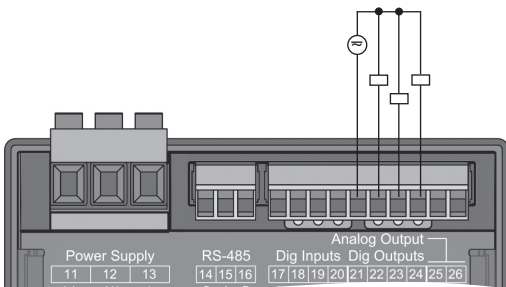

Fig. Connection of digital/pulse outputs

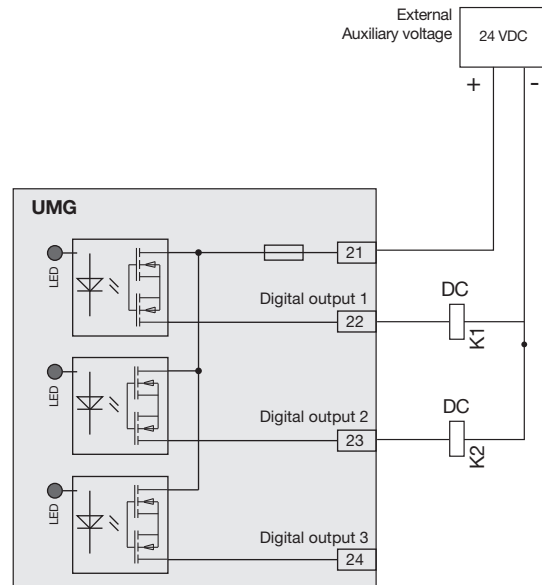

Fig. Connection example of two relays to the digital outputs

9.3 LED status bar

The LED status bar on the back of the measurement device shows the different states of the inputs and outputs.

Digital inputs

The LED assigned to the respective input lights up green if a signal of at least 4 mA is flowing at this interface.

Digital outputs

The respective LED assigned to the output lights up green when the output is set as active - independent of any further connection to this interface.

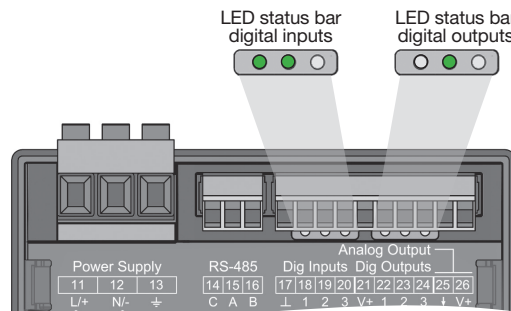

Fig. LED status bars of the digital inputs and outputs

10. Analog outputs

The measurement device has 1 passive analog output which can deliver a current of 0 - 20 mA. An external power supply unit (24 V DC) is required for operation.

The connectable load must not exceed a resistance of 300 ohms. If the analog output is loaded with a higher resistance, the output range(20 mA) is restricted.

The measured value assigned to the analog output, the start and end values, and the output range of **4 - 20 mA** or **0 - 20 mA** must be set using the GridVis® software (for more information, refer to section „13.15 Configuration of the analog output“ on page 75).

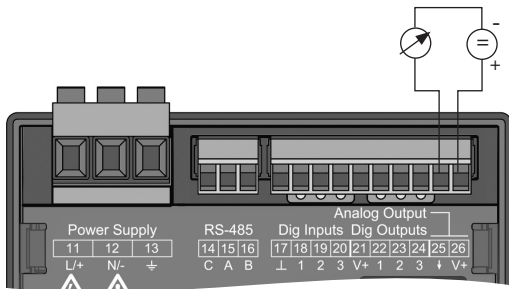
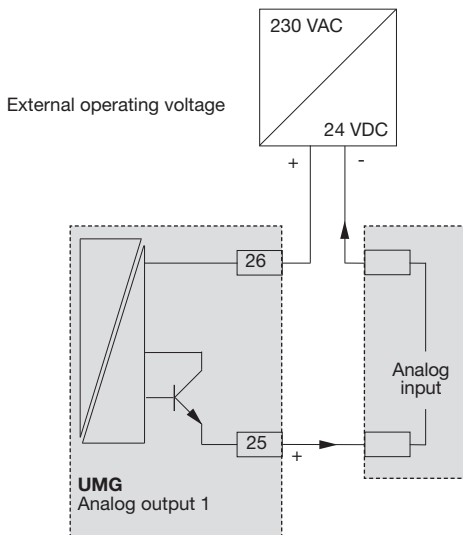

Fig. Analog output connection



11. Operation

The device is operated via 6 function buttons which have different functions:

- Selecting measuring displays.
- Navigation within the menus.
- Editing device settings.

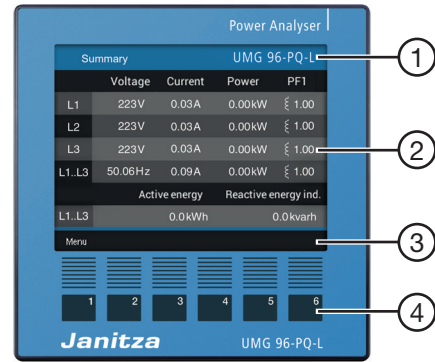

Fig. Measuring display “Overview”

Item	Function/Designation
1	Title displayed
2	Measured values
3	Labeling of the function buttons
4	Function buttons

Tab.: Operating the device

11.1 Button function

	Functions
1	<ul style="list-style-type: none"> · Display Menu · Exit Menu · Cancel action (Esc)
2	<ul style="list-style-type: none"> · Go to the start screen. · Select position (to the left “◀”). · Configuration of a measuring display as the start screen (press until message appears).
3	<ul style="list-style-type: none"> · Select menu item or position (down “▼”). · Change (selection, number -1).
4	<ul style="list-style-type: none"> · Select menu item or position (up “▲”). · Change (selection, number +1)
5	<ul style="list-style-type: none"> · Select position (to the right “▶”)
6	<ul style="list-style-type: none"> · Confirm selection (Enter)

11.2 Measuring display “Overview”

Start screen:

After a power recovery, the measurement device starts with the *Overview* measuring display.

The *Overview* measuring display contains the device name and an overview of important measured values. In the delivery condition, the device name consists of the type and the serial number of the measurement device.

Button 2 (*Home*) takes you back to the start screen *Summary* from any display (default setting).

Summary		UMG 96-PQ-L			
	Voltage	Current	Power	PF1	
L1	223V	0.03A	0.00kW	1.00	
L2	223V	0.03A	0.00kW	1.00	
L3	223V	0.03A	0.00kW	1.00	
L1..L3	50.06Hz	0.09A	0.00kW	1.00	
Active energy		Reactive energy ind.			
L1..L3	0.0kWh		0.0kvarh		
Menu					

Fig. Measuring display “Overview” - measurement in a three-phase four-wire network (default setting).

11.3 Menu

Button 1 opens the menu of your measurement device:

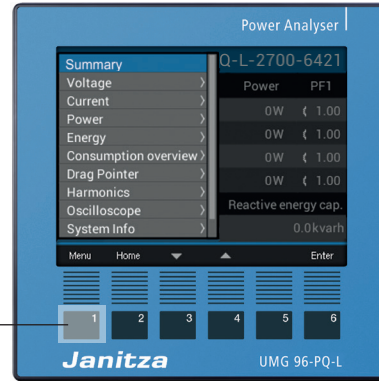

Fig. Opening a menu

Button 1: Menu

i INFORMATION

- The representation above of the measuring display “Overview” depends on the grid system configuration of your measurement device. In this regard, please take note of section „12.4.4 Connection variant“ on page 48.
- To configure a new start screen, please refer to section „11.5 Configuring a new start screen“ on page 43.

11.4 Overview of menu displays

Menu

- **Overview**
- **Voltage**
 - Voltage L-N ¹⁾
 - Voltage L-L
 - THD U
 - History
 - Phasor diagram
- **Current**
 - Current
 - Gridded average values
 - THD I
 - TDD I
 - History
 - History L4
- **Power**
 - Total power
 - Gridded average values
 - Active power ¹⁾
 - Reactive power ¹⁾
 - Apparent power ¹⁾
 - Active power history
 - Reactive power history
 - Apparent power history
- **Energy**
 - Active energy
 - Reactive energy
 - Apparent energy
 - Tariff
- **Consumption overview**
 - Daily
 - Active energy
 - Reactive energy
 - Apparent energy
 - Monthly
 - Active energy
 - Reactive energy
 - Apparent energy

Drag indicator

- Current
 - Current L1
 - Current L2
 - Current L3
- Active power
 - Active power L1
 - Active power L2
 - Active power L3
 - Active power L1 .. L3
- Apparent power
 - Apparent power L1
 - Apparent power L2
 - Apparent power L3
 - Apparent power L1 .. L3

Harmonics

- Voltage
 - L1 / L2 / L3
- Current
 - L1 / L2 / L3
 - L4

Oscilloscope

- Voltage
 - L1 / L2 / L3
 - L1 .. L3
- Current
 - L1 / L2 / L3
 - L1 .. L3
 - L4

Events

- All events
- Voltage
 - Overvoltage
 - Undervoltage
 - Voltage interruption
- Current
 - Overcurrent
- External events
 - Digital inputs
 - Modbus
- Comparators
 - Group 1
 - Group 2

1) Only available in a 3P4W network (star)

System info

- Com. RS-485
- Peripherals
- Comparator groups
 - Comparator group 1
 - ...
 - Comparator group 5
- Basic device info

Configuration

- Language
 - German
 - English
- Communication/Fieldbus
 - Device address
 - Baud rate
 - Data frame
- Measurement
 - Transformer
 - Connection variant
 - Nominal current
 - Nominal frequency
- Display
 - Brightness
 - Standby after
 - Brightness (standby)
 - Auto Home return
 - Home delay
 - Colors
- System
 - Version ²⁾
 - Serial number ²⁾
 - Time
 - Password
 - Reset
- Modbus editor
 - Address
 - Value
 - Minimum ²⁾
 - Maximum ²⁾
 - Type ²⁾
 - Access ²⁾

Select the menu item:

- Use *buttons* 3 (▼) and 4 (▲) to select the menu item.
- Confirm this with *button* 6 (Enter).
- Use *button* 1 (Esc) to leave the selection.
- Use *button* 2 (Home) to go to the “Overview” start screen (default setting).

 INFORMATION

- **The meter has the factory password 00000 (no password).**
- The measurement device locks the device configuration for 10 min. if the password is entered incorrectly 5 times.
- Write down your password and keep it safe!
- Without the password you cannot configure your device! Notify the device manufacturer’s Support if the password is lost!

11.5 Configuring a new start screen

In the default setting of the measurement device, the “Overview” display is configured as the start screen.

Any **measuring display** of the device can be configured as the new start screen by pressing and holding *button* 2 (Home).

- To do so, go to the corresponding **measuring display** and press *button* 2 (Home) until the message “**Home display reset**” appears.

 INFORMATION

The entries in the menu display overview depend on the network system configuration of your measurement device (three-phase 4-wire system or three-phase 3-wire system). In this regard, please take note of section “12.4.4 Connection variant” on p. 48.

2) Not configurable

12. Configuration

12.1 The Configuration window

The *Configuration* menu contains all configurable device parameters.

i INFORMATION

If the device is password protected, the password is required for configuration.
The device requires a supply voltage for configuration (see Sect. 13.1 on page 60).

Opening the Configuration menu

- Press button 1 (*Menu*) to open the menu.
- Use buttons 3 (▼) and 4 (▲) to select the menu item *Configuration* and confirm with button 6 (*Enter*).

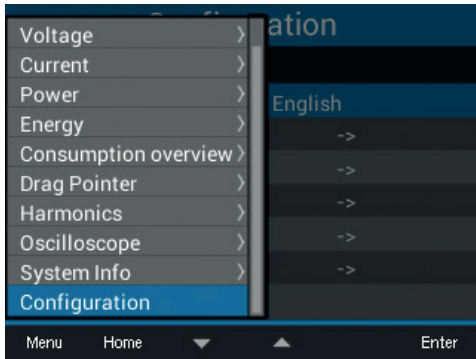

Fig. "Configuration" menu item

- If no password is entered, the *Configuration* window will open immediately.

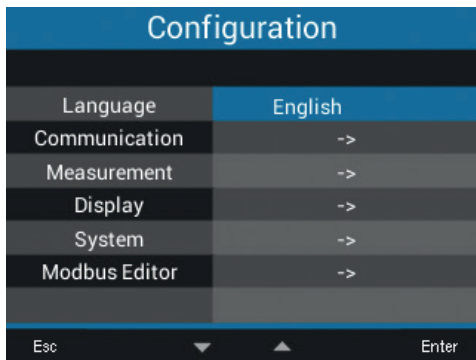

Fig. Configuration window with activated language item.

- Make the necessary settings, especially for the grid system and the transformer ratio (see section „12.4 Measurement“ on page 46).

Enter password (if required)

- Press button 6 (*Enter*). The digits 00000 are displayed in yellow (input mode).
- Enter the first digit of the password using buttons 3 (▼) and 4 (▲).
- Switch between the digits of the password using buttons 2 (◀) and 5 (▶).
- Confirm the password with button 6 (*Enter*).

12.2 Language

Use the *Language* item of the *Configuration* window to configure the language for the device's user interface:

- Open the *Configuration* window as previously described.
- Use buttons 3 (▼) and 4 (▲) to select the item *Language* and confirm with button 6 (*Enter*).
- The item *Language* is shown in yellow letters.

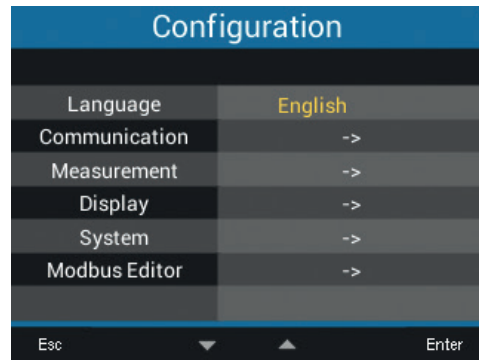

Fig. The Language Configuration window

- Use buttons 3 (▼) and 4 (▲) to select the language (*German* or *English*) and confirm with button 6 (*Enter*).
- The user interface entries change to the selected language.
- Use button 1 (*Esc*) to return to the menu.
- Then press button 2 *Home* to go to the start screen.

12.3 Communication

Use the *Communication* item of the *Configuration* window to configure parameters for the RS-485 interface of your device.

- Open the *Configuration* window as previously described.
- Use buttons 3 (▼) and 4 (▲) to select the item *Communication* and confirm with button 6 (Enter).
- The *Communication* window appears with the parameters:
 - Device address.
 - Baud rate.
 - Data frame.

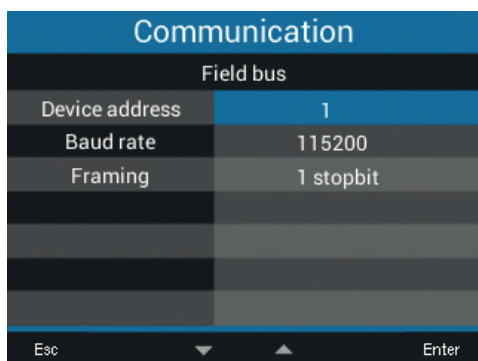

Fig. Communication window for fieldbus parameters (RS-485 interface)

- Use the *Communication* window to configure the parameters for the fieldbus (RS-485 interface), such as **Device address**, **Baud rate** and **Data frame** by selecting the respective item and confirming with button 6 (Enter).
- Depending on the parameter selected, the corresponding item is shown in "yellow".
- Use buttons 2 (◀) and 5 (▶) to change the position of the digit to be set for each item and use buttons 3 (▼) and 4 (▲) to change the digit (-1/+1).
- Confirm your entries with button 6 (Enter) or end the action by pressing button 1 (Esc).
- To return to the start screen, press button 1 twice (Esc) and then press button 2 (Home).

Settings:

- **Device address:**
Select a device address for the device with which the device can be addressed in the bus structure. Each device address exists only once in a bus structure!
Setting range: 1 - 250
Default value: 1
- **Baud rate:**
Select a uniform baud rate for all devices in the bus structure!
Setting range: *Auto*, 9600, 19200, 38400, 57600, 115200 kbps
Default value: *Auto*

i INFORMATION

- The display *Auto (searching...)* means that the device is currently determining the baud rate suitable for communication with other devices on the fieldbus.
- The *Auto* setting is not available if the measurement device with RCM module is configured as an Ethernet gateway for other measurement devices.

- **Data frame:**
Select a uniform data frame for all devices in the bus structure.
Setting range:
 - *odd* (parity *odd*, with 1 stop bit)
 - *even* (parity *even*, with 1 stop bit)
 - 1 stop bit (parity *none*, with 1 stop bit).
 - 2 stop bits (parity *none*, with 2 stop bits).
 - Default value: 1 stop bit(no parity).

! CAUTION

Material damage due to incorrect network settings.

Incorrect network settings can cause faults in the IT network.

Consult your network administrator for the correct network settings for your device.

12.4 Measurement

In the "Measurement" menu, configure the ratio of the current and voltage transformers, the connection variants, the nominal current and the nominal frequency.

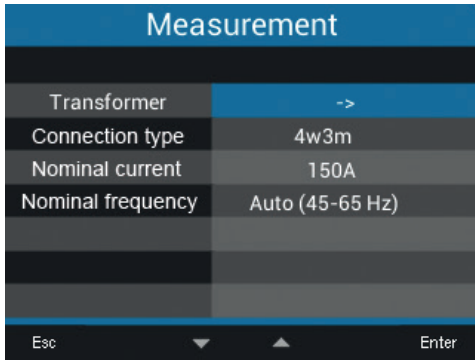

Fig. Measurement window with the entries transformer, connection variant, nominal current, nominal frequency

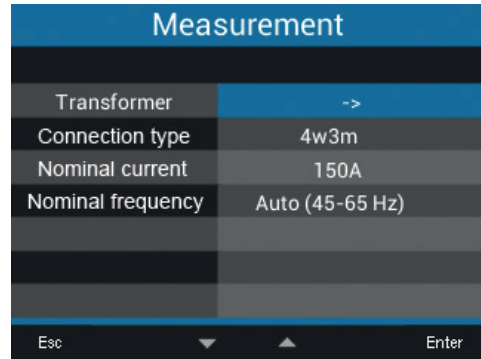

Fig. Measurement window with the item Transformer activated.

12.4.1 Current and voltage transformers

Use **Measurement > Transformers** to configure:

- The transformer ratio of the millivolt current measurement inputs (L1 to L3).
- The type of current sensors used.
- The transformer ratio of the 4th current measuring channel "L4" (optional)

	Setting range	Default value
Current sensor type		
Current sensor	Low power / Rogowski	Rogowski
Current transformer (for L1-L3; L4)		
primary	1 - 10000 A	5 A
secondary	1 - 400 mV (800 mV) ¹⁾	333 mV
Voltage transformer (for L1, L2, L3)		
primary	100 - 60000 V	400 V
secondary	100 - 400 V	400 V

¹⁾ Low Power: 400 mV, Rogowski: 800 mV

Tab. Transformer settings, UMG 96-PQ-L-LP

Open Measurement > Transformers

- Open the *Configuration* window as previously described.
- Use buttons 3 (▼) and 4 (▲) to select the item *Measurement* and confirm with button 6 (Enter).
- The *Measurement* window appears.
- Use buttons 3 (▼) and 4 (▲) to select the item *Transformer* and confirm with button 6 (Enter).

- The *Measurement* window appears with the settings for the current and voltage transformers (primary to secondary side).

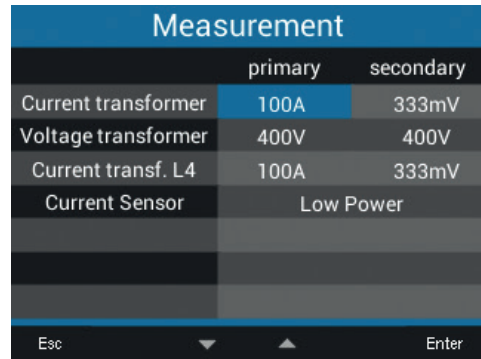

Fig. Measurement window with the entries for the transformers

Setting the transformer ratio

Configure the current and voltage transformers according to their specifications on the rating plate or in the technical data.

- Use buttons 2 (◀), 3 (▼), 4 (▲) and 5 (▶) to select the entry for the primary or secondary side of the transformer to be set and confirm with button 6 (Enter).
- The selected item is shown "yellow".
- Use buttons 2 (◀) and 5 (▶) to change the position of the digit to be set for each item and use buttons 3 (▼) and 4 (▲) to change the digit (-1/+1).
- Confirm your entries with button 6 (Enter) or end the action by pressing button 1 (Esc).

12.4.2 Current sensor type

For correct measurement results, you must set the *Current Sensor* according to the table based on the current sensor type used:

Current sensor type	Max. sensor output signal	Device setting
Low power current transformers	400 mV	<i>Low Power</i>
Active Rogowski coil (with integrator)	400 mV ¹⁾	<i>Low Power</i>
Passive Rogowski coil (integrator in measurement device)	800 mV ¹⁾	<i>Rogowski</i>

¹⁾ The transformer ratio of Rogowski coils may be significantly different at 60 Hz as compared to 50 Hz – set according to the manufacturer's specifications depending on the mains frequency

Select current sensor type

- Under *Measurement > Transformers*, select the item *Current Sensor* using buttons 3/4 ("▼"/"▲") and press button 6 (*Enter*).
- The configuration window for the current sensor type appears.

Measurement		
	primary	secondary
Current transformer	8000A	800mV
Voltage transformer	400V	400V
Current transf. L4	8000A	800mV
Current Sensor	Rogowski	
Esc	▼	▲
		Enter

Fig. Measurement window with the L4 current transformer settings

- Use buttons 3 (▼) and 4 (▲) to select the current sensor used.
- Confirm your selection by pressing button 6 (*Enter*).
- To return to the start screen, press button 1 three times (*Esc*) and then press button 2 (*Home*).

12.4.3 I4 current transformer

If you are using the 4th current measuring channel, also configure the current transformer ratio for the I4 current measurement (e.g. neutral conductor measurement) in the item *Transformers*.

Setting the current transformer ratio

- Under *Measurement > Transformers*, select the item *Current transformer L4* using buttons 3/4 ("▼"/"▲").

Measurement		
	primary	secondary
Current transformer	100A	333mV
Voltage transformer	400V	400V
Current transf. L4	100A	333mV
Current Sensor	Low Power	
Esc	▼	▲
		Enter

Fig. Measurement window with the L4 current transformer settings

- Select the primary or secondary side using buttons 2/5 (◀ / ▶) and confirm with button 6 (*Enter*).
- The selected item is shown "yellow".
- Use buttons 2 (◀) and 5 (▶) to change the position of the digit to be set for each item and use buttons 3 (▼) and 4 (▲) to change the digit (-1/+1).
- Confirm your entries with button 6 (*Enter*) or end the action by pressing button 1 (*Esc*).
- To return to the start screen, press button 1 three times (*Esc*) and then press button 2 (*Home*).

12.4.4 Connection variant

- Open the *Configuration* window as previously described.
- Use buttons 3 (▼) and 4 (▲) to select the item *Measurement* and confirm with button 6 (Enter).
- The *Measurement* window appears.
- Use buttons 3 (▼) and 4 (▲) to select the item *Connection variant* and confirm with button 6 (Enter).

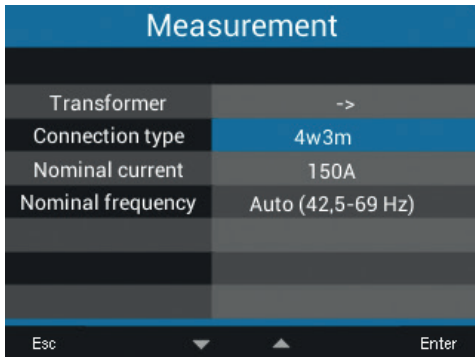

Fig. Measurement window with the entry Connection Variant marked

- The selected item is shown "yellow".
- Select the desired connection variant with buttons 3 (▼) and 4 (▲).
- Confirm your entries with button 6 (Enter) or end the action by pressing button 1 (Esc).
- To return to the start screen, press button 1 three times (Esc) and then press button 2 (Home).

Setting range **Connection variant**: 4w3m, 3w2u, 3w2m, 3p1w.

Connection variant 4w3m

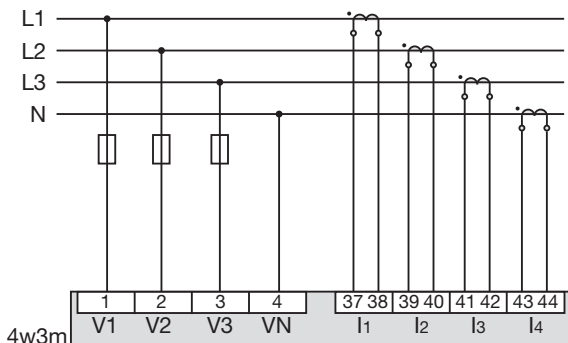

Fig. Connection variant 4w3m - measurement in a three-phase 4-conductor network with asymmetrical load.

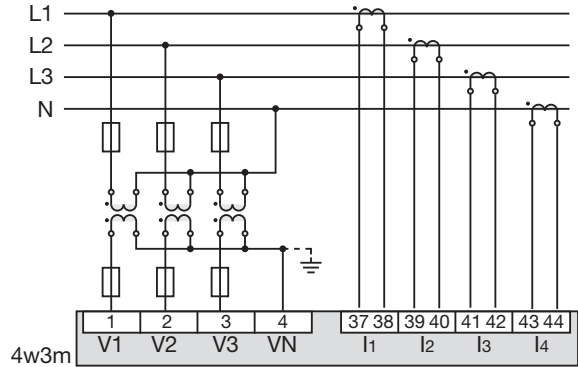

Fig. Connection variant 4w3m - Measurement via 3 voltage transformers in a three-phase 4-conductor network with asymmetrical load.

Connection variant 3w2u

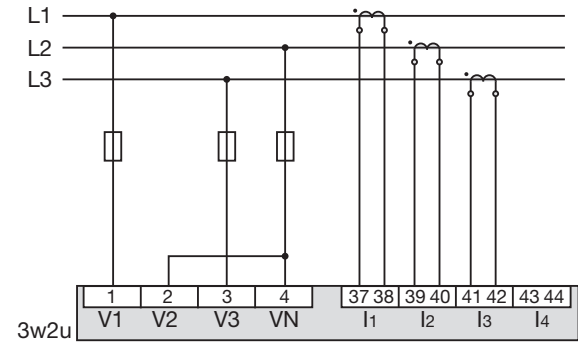

Fig. Connection variant 3w2u - measurement in a three-phase 3-conductor network with asymmetrical load.

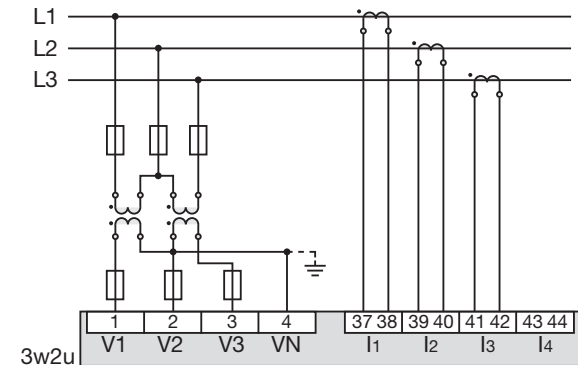

Fig. Connection variant 3w2u - measurement via 2 voltage transformers in a three-phase 3-conductor network with an asymmetrical load.

ⓘ INFORMATION

In the GridVis® software, configure the connection variant under *Measurement > Mains*.

Connection variant 3w2m

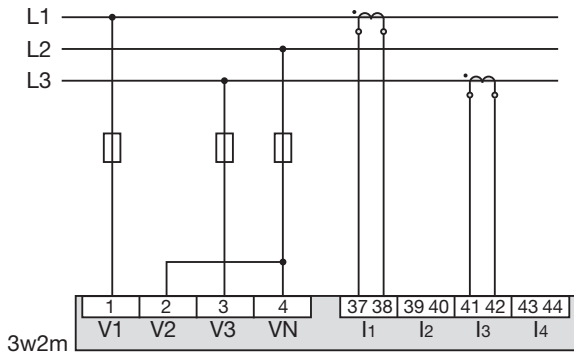

Fig. Connection variant 3w2m - measurement in a three-phase 3-conductor network with asymmetrical load.

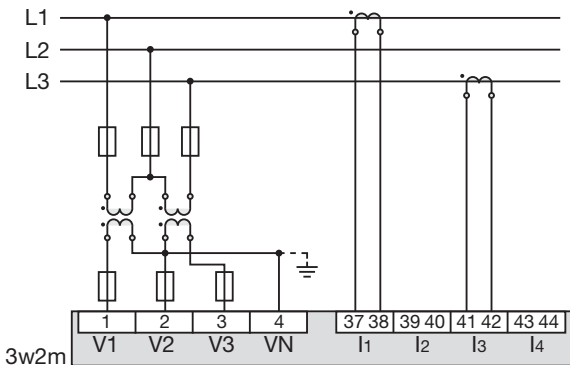

Fig. Connection variant 3w2m - measurement via 2 voltage transformers in a three-phase 3-conductor network with an asymmetrical load.

Connection variant 3p1w (3 x L3)

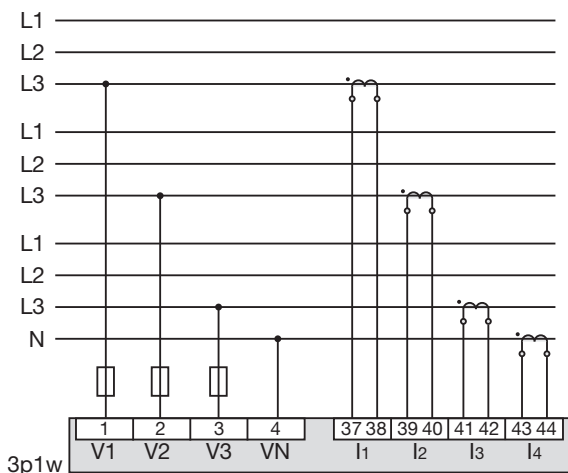

Fig. Three systems with uniform loading of the phases. The unapplied measured values L2/L3 or L1/L3 or L1/L2 of the respective systems are calculated.

Only use the 3p1w connection variant if it is ensured that the connected loads in each system always load all 3 phases equally!

In the connection variant **3p1w**, the power and energy values determined in one phase of a system are multiplied by the factor 3 and displayed as total values of the system.

In the *Overview* menu (start screen), the power is displayed as "3 x P" and all three phases are displayed as "L3".

Summary		UMG 96-PQ-L			
	I	I max.	U	3 x P	
L3	0.000A	0.000A	0V	0.00kW	
L3	0.000A	0.000A	0V	-0.00kW	
L3	0.000A	0.000A	0V	0.00kW	
	---	---	---	---	
Frequency					
L3	50.00Hz				
Menu					

Fig. Start screen for the connection variant 3p1w (3 x L3)

INFORMATION

The start screen displays the correct measured values in the 3p1w (3 x L3) connection variant. Other display indicators are not designed for this connection variant and may show invalid measured values. This mainly affects the following menus or displays:

- Voltage >Phasor diagram
- Power (active, reactive and apparent power)
- Energy (active, reactive and apparent energy, tariff)
- Consumption overview
- Drag indicator

12.4.6 Nominal current

For a defined operation of the device, you need the nominal current in addition to the settings of the current and voltage transformer ratios.

- Open the *Configuration* window as previously described.
- Use buttons 3 (▼) and 4 (▲) to select the item *Measurement* and confirm with button 6 (Enter).
- The *Measurement* window appears.
- Use buttons 3 (▼) and 4 (▲) to select the item *Nominal current* and confirm with button 6 (Enter).

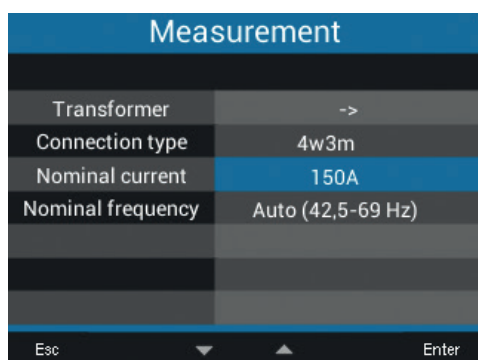

Fig. Measurement window with the item *Nominal current* activated.

- The item *Nominal current* is shown "yellow".
- Use buttons 2 (◀) and 5 (▶) to change the position of the digit to be set for each item and use buttons 3 (▼) and 4 (▲) to change the digit (-1/+1).
- Confirm your entries with button 6 (Enter) or end the action by pressing button 1 (Esc).
- To return to the start screen, press button 1 twice (Esc) and then press button 2 (Home).

Nominal current settings:
Setting range: **0 - 999999 A**
Default setting: **150 A**

12.4.5 Nominal frequency

The device requires the mains frequency for the measurement and calculation of measured values. The device is suitable for measurements in networks with a frequency range of 45 - 65 Hz.

- Open the *Configuration* window as previously described.
- Use buttons 3 (▼) and 4 (▲) to select the item *Measurement* and confirm with button 6 (Enter).
- The *Measurement* window appears.
- Use buttons 3 (▼) and 4 (▲) to select the item *Nominal frequency* and confirm with button 6 (Enter).

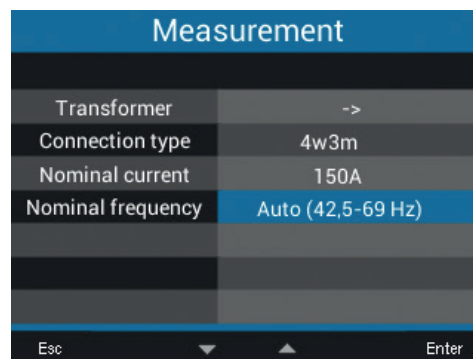

Fig. Measurement window with the item *Nominal frequency* activated.

- The item *Nominal frequency* is shown "yellow".
- Select your frequency range with buttons 3 (▼) and 4 (▲).
- Confirm your entries with button 6 (Enter) or end the action by pressing button 1 (Esc).
- To return to the start screen, press button 1 twice (Esc) and then press button 2 (Home).

Setting ranges for **Nominal frequency**:

- **Auto** (45-65 Hz) - **Standard setting**
- **60 Hz** (const. frequency)
- **50 Hz** (const. frequency)

i INFORMATION

Measurement devices with the setting **Auto** need about 10 seconds after being switched on to determine the mains frequency. During this time, the measurement device assumes 50 Hz.

To determine the mains frequency, the measurement device requires a voltage $> 20V_{rms}$ (4-wire measurement) or a voltage $L1-L2 > 34V_{rms}$ (3-wire measurement) on voltage measurement input V1.

i INFORMATION

If the mains frequency is outside the range of 45-65 Hz:

- There is no error or warning alert.
- When a constant frequency (50/60 Hz) is indicated, the corresponding setting is used.
- When automatic frequency detection is selected (Auto), the last determined frequency in the range of 45-65 Hz is used.

The determination of the frequency runs over a period of 10 seconds. The frequency does **not** represent a 200 ms measured value!

12.5 Display

Use the *Display* item on the measurement device to configure the following display settings:

- Display brightness,
 - Energy saving (standby),
 - Return to the start screen, and
 - Use of colors for L1, L2, L3.
- Open the *Configuration* window as previously described.

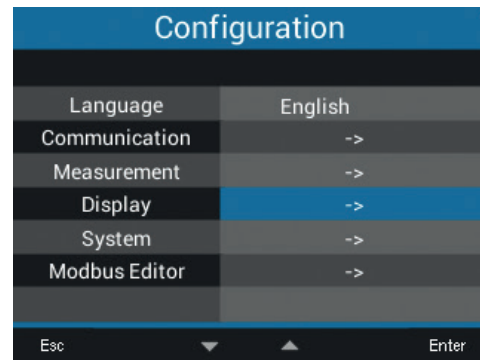

Fig. Configuration window with Display item activated.

- Use buttons 3 (▼) and 4 (▲) to select the item *Display* and confirm with button 6 (Enter).
- The *Display* window appears.



Fig. Display window

- Use buttons 3 (▼) and 4 (▲) to select the corresponding item of the *Display* window and confirm with button 6 (Enter).
- The selected item is shown "yellow".
- Use buttons 2 (◀) and 5 (▶) to change the position of the digit to be set for each item and use buttons 3 (▼) and 4 (▲) to change the digit (-1/+1).
- Confirm your entries with button 6 (Enter) or end the action by pressing button 1 (Esc).

- To return to the start screen, press button 1 twice (*Esc*) and then press button 2 (*Home*).

Other settings in the *Display* window:

Display	
Brightness	70%
Standby delay	900s
Brightness (standby)	30%
Auto Home return	Yes
Home delay	90s
Colors	->
Esc	Enter

Fig. Display window

12.5.1 Brightness

Display brightness of the measurement device.

- Setting range: 30% - 100%
- Default value: 70%

with 30% = dark
100% = very bright

12.5.2 Standby after

Time in seconds after which the display brightness is set to the *Brightness (Standby)* that has been configured.

- Setting range: 60 s - 3600 s
- Default value: 900 s

12.5.3 Brightness (standby)

Display brightness to which the meter switches after the standby time has expired.

- Setting range: 20% - 60%
- Default value: 30%

with 20% = dark
60% = very bright

12.5.4 Auto Home return

The display automatically shows the start screen again after the set time. When activated, this function prevents the *Configuration* menu from remaining open unintentionally and thus allowing unauthorized access.

- Setting range: Yes, No

12.5.5 Home delay

The display automatically shows the start screen again after this time has elapsed.

- Setting range: 30 s - 300 s
- Default value: 90 s

12.5.6 Colors

Colors for the display of current and voltage in the graphical visualizations.

- Open the *Configuration* window as previously described.
- Use buttons 3 (▼) and 4 (▲) to select the item *Display* and confirm with button 6 (Enter).
- The *Display* window appears.
- Use the buttons 3 (▼) and 4 (▲) to select the item *Colors* and confirm with button 6 (Enter).
- The *Colors* window appears.

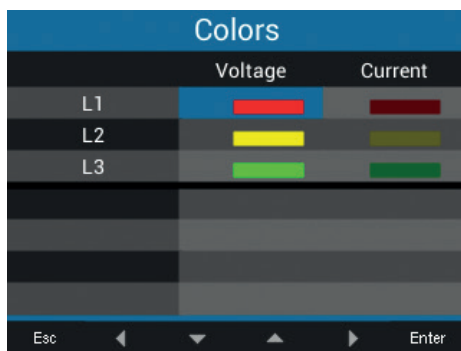

Fig. Colors window

- Use buttons 2 (◀), 3 (▼), 4 (▲) and 5 (▶) to select the color for the voltage or current of the phase to be set and confirm with button 6 (Enter).
- The selected color is shown framed in blue.
- Use buttons 3 (▼) and 4 (▲) to select the desired color and confirm with button 6 (Enter) or end the action with button 1 (Esc).
- To return to the start screen, press button 1 three times (Esc) and then press button 2 (Home).

12.6 System

In the *System* window, the user of the measurement device can:

- View device-specific system settings.
- Configure a password.
- Delete or reset measured values and device parameters.
- Open the *Configuration* window as previously described.
- Use buttons 3 (▼) and 4 (▲) to select the item *System* and confirm with button 6 (Enter).

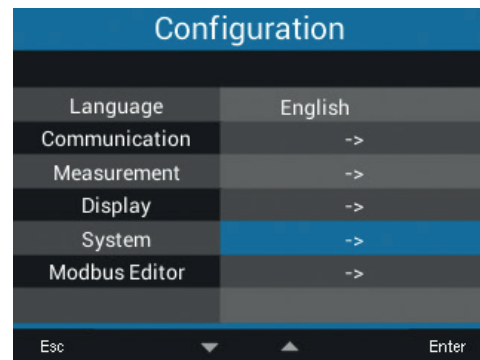

Fig. Configuration window with the System item activated.

- The *System* window appears.

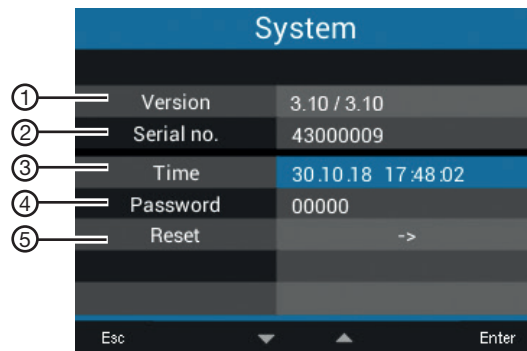

Fig. System window

Item	Function/Designation
1	Firmware version
2	Serial number of the measurement device
3	Date/time
4	Password function
5	Reset function

Tab. Entries in the System window

12.6.1 Firmware/Serial number

The firmware and the serial number of the measurement device are required for support requests or registration on the homepage (www.janitza.com).

12.6.2 Date/time

Here you can set the date and time in the device. A changed time is adopted immediately for all newly recorded measured values.

The settings for time synchronization, the date and time zones can be defined using the GridVis® software.

The date and time can also be synchronized and monitored across devices (see Sect. 13.21 on page 93).

12.6.3 Password

Use a password to block access to the configuration. The device can only be configured after entering the password.

The password consists of a number combination of up to 5 digits.

Setting ranges:

- 1-99999 = with password
- 00000 = without password

Default value:

00000 = without password

The measurement device is configured ex works without a password (00000).

For a password change, you need the current password.

i INFORMATION

- The measurement device locks the device configuration for 10 min. if the password is entered incorrectly 5 times.
- Write down your password and keep it safe!
- Without the password you cannot configure your device! Notify the device manufacturer's Support if the password is lost!

Setting the password

- Open the *Configuration* window as previously described.
- Use buttons 3 (▼) and 4 (▲) to select the item *System* and confirm with button 6 (Enter).
- The *System* window appears.
- Use buttons 3 (▼) and 4 (▲) to select the item *Password* and confirm with button 6 (Enter).
- The item *Password* is shown "yellow".

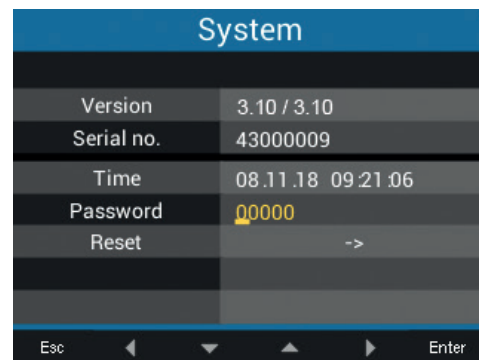

Fig. System window with the item Password activated

- Use buttons 2 (◀) and 5 (▶) to change the position of the digit to be set for each item and use buttons 3 (▼) and 4 (▲) to change the digit (-1/+1).
- Confirm your entries with button 6 (Enter) or end the action by pressing button 1 (Esc).
- To return to the start screen, press button 1 twice (Esc) and then press button 2 (Home).

12.6.4 Reset

This function is used to delete and reset measured values and device parameters.

Energy

You can delete all energy meters in the device simultaneously. It is not possible to select certain energy meters.

- Open the *Configuration* window as previously described.
- Use buttons 3 (▼) and 4 (▲) to select the item *System* and confirm with button 6 (Enter).
- The *System* window appears.
- Use buttons 3 (▼) and 4 (▲) to select the item *Reset* and confirm with button 6 (Enter).
- The *Reset* window appears.

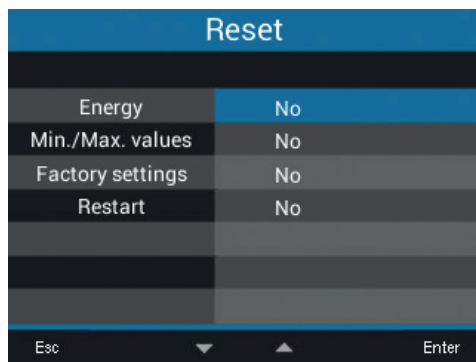

Fig. Reset window, resetting the energy meters

- Use buttons 3 (▼) and 4 (▲) to select the item *Energy* and confirm with button 6 (Enter).
- The item *Energy* is shown "yellow".
- Use buttons 3 (▼) and 4 (▲) to select "Yes" or "No".
- Confirm your entries with button 6 (Enter) or end the action by pressing button 1 (Esc).
- To return to the start screen, press button 1 three times (Esc) and then press button 2 (Home).

Minimum and maximum values

With this function, the device user deletes all min. and max. values in the device simultaneously. It is not possible to select certain energy meters.

i INFORMATION

Before commissioning, delete any production-related contents of the energy meters, Min./Max. values and records!

- Open the *Configuration* window as previously described.
- Use buttons 3 (▼) and 4 (▲) to select the item *System* and confirm with button 6 (Enter).
- The *System* window appears.
- Use buttons 3 (▼) and 4 (▲) to select the item *Reset* and confirm with button 6 (Enter).
- The *Reset* window appears.

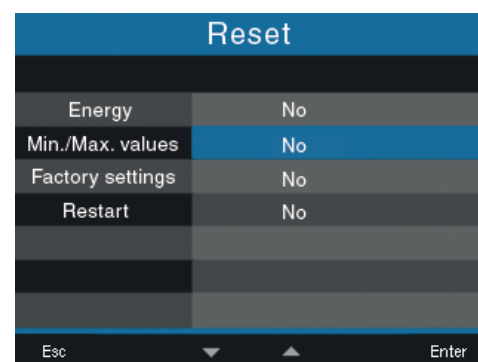

Fig. Reset window, delete min/max values

- Use buttons 3 (▼) and 4 (▲) to select the item *Min./max. values* and confirm with button 6 (Enter).
- The item *Min./Max. values* is shown "yellow".
- Use buttons 3 (▼) and 4 (▲) to select "Yes" or "No".
- Confirm your entries with button 6 (Enter) or end the action by pressing button 1 (Esc).
- To return to the start screen, press button 1 three times (Esc) and then press button 2 (Home).

Standard factory settings

This function resets all settings, such as configurations and recorded data, to the factory settings.

- Open the *Configuration* window as previously described.
- Use buttons 3 (▼) and 4 (▲) to select the item *System* and confirm with button 6 (Enter).
- The *System* window appears.
- Use buttons 3 (▼) and 4 (▲) to select the item *Reset* and confirm with button 6 (Enter).
- The *Reset* window appears.



Fig. Reset window, standard factory settings

- Use buttons 3 (▼) and 4 (▲) to select the item *Standard factory setting* and confirm with button 6 (Enter).
- The item *Factory setting* is shown "yellow".
- Use buttons 3 (▼) and 4 (▲) to select "Yes" or "No".
- Confirm your entries with button 6 (Enter) or end the action by pressing button 1 (Esc).
- Use button 6 (Enter) to confirm the warning message or end the action with button 1 (Menu).
- Pressing button 6 (Enter) resets the device to the standard factory settings.

Restart

This function restarts the measurement device.

- Open the *Configuration* window as previously described.
- Use buttons 3 (▼) and 4 (▲) to select the item *System* and confirm with button 6 (Enter).
- The *System* window appears.
- Use buttons 3 (▼) and 4 (▲) to select the item *Reset* and confirm with button 6 (Enter).
- The *Reset* window appears.



Fig. Reset window, restart device

- Use buttons 3 (▼) and 4 (▲) to select the item *Restart* and confirm with button 6 (Enter).
- The item *Restart* is shown "yellow".
- Use buttons 3 (▼) and 4 (▲) to select "Yes" or "No".
- Confirm your entries with button 6 (Enter) or end the action by pressing button 1 (Esc).
- Pressing button 6 (Enter) restarts the device.

12.7 Modbus editor

The function **Modbus Editor** is used to configure various functions or to read out measured values directly on the measurement device, without parametrization software or a network connection. Your measurement device does not require a network connection for this.

i INFORMATION

Optionally, you can configure Modbus addresses easily and conveniently in the GridVis® software.

You can use the Modbus address list (download at www.janitza.com) to configure the **analog output** of the measurement device, for example, via the device keyboard.

Example of configuring the measured value for the analog output:

To assign a measured value to the analog output of your measurement device, write the Modbus address of the measured value (see the table of frequently used measured values) to the

Modbus address 30001

To configure a start value for your measured value, write the start value to the

Modbus address 30002

A final value for your measured value can be entered in

Modbus address 30004

To assign the output ranges to the analog output of a device, write as follows to the

Modbus address 30006

- a **0** for the output range **0-20 mA**;
- a **1** for the output range **4-20 mA**.

i INFORMATION

Further information on the analog outputs can be found in section "10. Analog outputs" on p. 40 and in section "13.15 Configuration of the analog output" on page 75.

Table of frequently used measured values

Frequently used measured values and their Modbus addresses for output on the **analog output (Modbus address 30001)**:

Modbus address	Measured value
19026	Active power, sum L1-L3, instantaneous value
19042	Reactive power, sum L1-L3, instantaneous value
19012	Current L1, instantaneous value
19014	Current L2, instantaneous value
19016	Current L3, instantaneous value
1050	Cos phi sum L1-L3, instantaneous value
20053	Neutral conductor current I4, instantaneous value
For measurement devices with RCM module	
20055	Residual current RCM 1 (I5), instantaneous value
20057	Residual current RCM 2 (I6), instantaneous value
20061	Temperature, instantaneous value

Tab. Modbus addresses of frequently required measured values.

i INFORMATION

A continuation of the table can be found in section "17.2 Modbus addresses of frequently used measured values" on page 115.

You can access the Modbus editor as follows:

- Open the *Configuration* window as previously described.
- Use buttons 3 (▼) and 4 (▲) to select the item *Modbus editor* and confirm with button 6 (Enter).

Configuration	
Language	English
Communication	->
Measurement	->
Display	->
System	->
Modbus Editor	->
Esc ▼ ▲ Enter	

Fig. Configuration window, Modbus editor

- The *Communication* window appears with the *Modbus editor*.

Communication	
Modbus Editor	
Address	30001
Value	0
Minimum	0
Maximum	65535
Type	short
Access	read/write
Esc ▼ ▲ Enter	

Fig. Communication window, Modbus editor

- Use buttons 3 (▼) and 4 (▲) to select the item *Address* or *Value* and confirm with button 6 (Enter).
- The selected item is shown "yellow".
- Use buttons 2 (◀) and 5 (▶) to change the position of the digit to be set for each item and use buttons 3 (▼) and 4 (▲) to change the digit (-1/+1).
- Confirm your entries with button 6 (Enter) or end the action by pressing button 1 (Esc).
- To return to the start screen, press button 1 twice (Esc) and then press button 2 (Home).

Example for the measured value *Active power*:

- In the *Configuration* window, select the item *Modbus editor* and confirm with button 6 (Enter).
- The *Communication/Modbus Editor* window appears with the items *Address* and *Value*.
- Select the item *Address* and press button 6 (Enter).
- The item *Address* is shown "yellow".
- Use buttons 2 (◀), 5 (▶), 3 (▼) and 4 (▲) to configure the number 30001.
- Confirm the entry with button 6 (Enter).
- Then select the item *Value* and press button 6 (Enter).
- The item *Value* is shown "yellow".
- Use buttons 2 (◀), 5 (▶), 3 (▼) and 4 (▲) to configure the number 19026 for the measured value *Active power sum, L1-L3*.
- Then configure the *Start* and *End value* of the active power in the addresses 30002 and 30004. For example, start value 500 W and end value 1000 W. Please note that the measured value variables must always be entered in the basic unit (e.g. W, A, V).

Further information on this example can be found in section „13.15 Configuration of the analog output“ on page 75.

i INFORMATION

- Measured values and Modbus addresses for the analog outputs can be configured easily and clearly in the GridVis® software (see www.janitza.com).
- Using the GridVis® software requires a connection between the measurement device and a PC (server) running the GridVis® software (see section „8. Connection and PC connections“ on page 34).
- Also observe the documentation for the RCM modules.

13. Commissioning

13.1 Applying the supply voltage

1. Connect the supply voltage with a terminal on the back of the device.
2. After connection of the supply voltage, the start screen *Overview* appears (default setting) on the display of your measurement device.
3. If no display appears, check whether the supply voltage is within the nominal voltage range.

CAUTION

Material damage due to disregard of the connection instructions!

Disregard of the connection instructions can damage or destroy your device.

Observe the following:

- Observe the voltage and frequency specifications on the rating plate!
- Do not use the device for measuring DC voltage!

INFORMATION

Before commissioning, delete any production-related contents of the energy meters, Min./Max. values and records (see section „Minimum and maximum values“ on page 55)!

13.2 Measured voltage

WARNING

Risk of injury due to electrical voltage!

If the device is exposed to surge voltages above the permissible overvoltage category, safety-relevant areas of insulation in the device can be damaged. This means that the safety of the product can no longer be guaranteed.

Only use the device in environments in which the permissible overvoltage category is not exceeded.

INFORMATION

In networks with nominal voltages that exceed the specified nominal voltages, connect the voltage measurement inputs via voltage transformers (see section „7.1 Nominal voltages“ on page 25)!

Connect measured voltage:

1. Connect the measured voltage to the terminals of the voltage measurement inputs on the back of the device.

2. After connecting the measured voltage, check the measured values displayed by the device for the voltages L-N and L-L.
Take into account any voltage transformer factors that may be set!

13.3 Measured current

The device:

- Is designed for connection of low-power current transformers or Rogowski coils according to the technical data (for current measurement ranges, see Page 112).
- Does not measure DC currents.

1. Adjust the factory-set current transformer ratio to the current transformers used.
2. Select the device setting suitable for the type of current sensor used:
 - *Low Power*: for small signal current transformers or Rogowski coils with integrator ("active").
 - *Rogowski*: for passive Rogowski coils (without power supply). This setting activates the integrator circuit in the measurement device.
3. Compare the current displayed on the device with the applied input current.
 - The currents must match after taking the current transformer ratio into account.
 - With no current flow, the device must display approx. 0 amps.

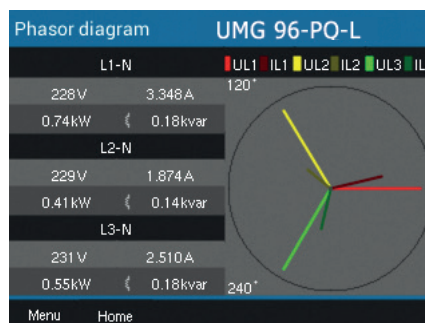

Fig. Phasor diagram

13.4 Frequency

For the measurement and calculation of measured values, the device requires the nominal or mains frequency. The mains frequency can either be specified by the user or determined automatically by the device.

- To determine the mains frequency, the voltage measurement input V1 requires a voltage greater than 20 V_{eff} (4-wire measurement) or an L1-L2 voltage of greater than 34 V_{eff} (3-wire measurement).
- The mains frequency must be in the range from 45 Hz to 65 Hz.
- If the measured voltage is not sufficiently high, the device cannot determine the mains frequency and therefore cannot carry out a measurement.

For further information, see section „12.4.5 Nominal frequency“ on page 50.

13.5 Direction of rotary field

Check the direction of the voltage rotating field in the measuring display of the device.

- Usually it is a "right" rotating field.

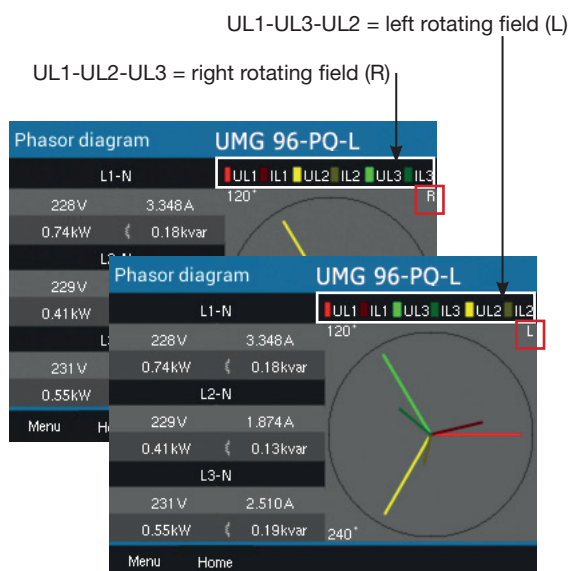

Fig. Phasor diagram window showing the phase sequence according to the direction of the rotating field.

To check the voltage rotating field, open the menu display "Phasor diagram":

- If you are not in the start screen, you can go to this view by pressing button 2 (Home).
- Open the menu with button 1 (Menu).

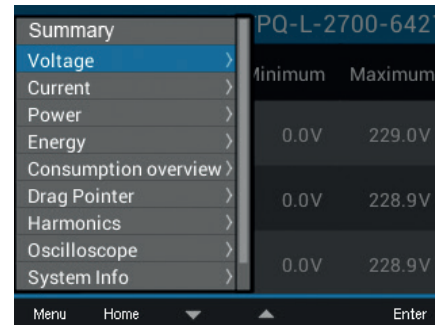

Fig. Voltage menu item

- Use buttons 3 (▼) and 4 (▲) to select the item Voltage and confirm with button 6 (Enter).
- The submenu with the item Phasor diagram appears.

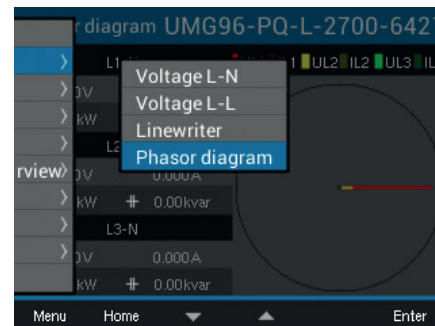

Fig. Submenu item Phasor diagram

- Use buttons 3 (▼) and 4 (▲) to select the item Phasor diagram and confirm with button 6 (Enter).
- The Phasor diagram window appears.

13.5.1 Fundamentals on the phasor diagram

The phasor diagram graphically describes the phase shift or phase angle between the voltage and the current. The phasors rotate at a constant angular speed – proportional to the frequency of the voltage and current – around an origin. The phasor diagram thus shows the momentary state of the variables in an AC circuit.

Representation of ohmic resistance:

- Voltage and current are in phase.

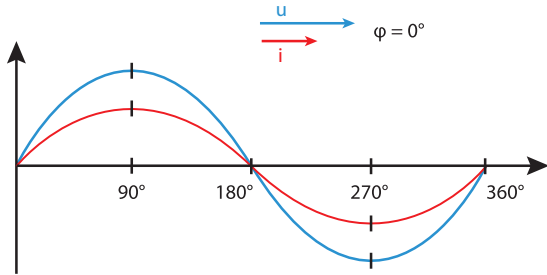

Representation of inductance:

- The voltage is ahead of the current.
- The phase shift for an “ideal coil” is 90° .

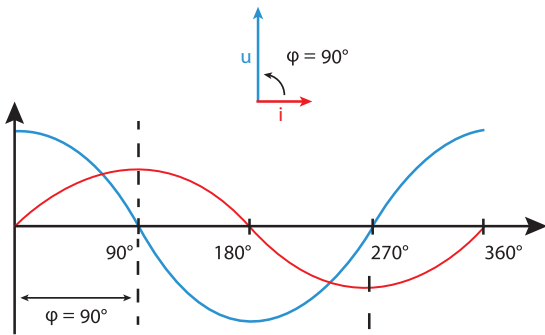

Representation of capacitance:

- The current is ahead of the voltage.
- The phase shift of an “ideal capacitor” is 90° .

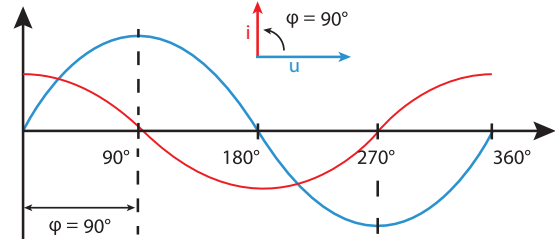

With a combination of the states, the phase angle “current to voltage” can assume values between -90° and $+90^\circ$.

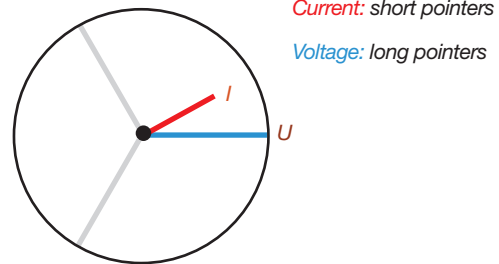

Example phasor diagram (3-phase)

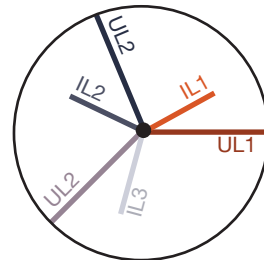

Current and voltage are shifted against each other. The current is ahead the voltage, i.e. the network is capacitively loaded.

13.6 Checking the voltage and current inputs using a phasor diagram

The phasor diagram can be used to check incorrect connections at the voltage and current inputs.

Example 1

Primarily ohmic load.

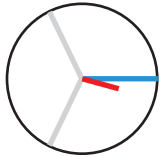

Voltage and current have only a small deviation in the phase position.

- The current measurement input is assigned to the correct voltage measurement input.

Example 2

Primarily ohmic load.

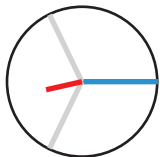

Voltage and current have a deviation of about 180° in the phase position.

- The measured current input is assigned to the correct voltage measurement input.
- In the current measurement under consideration, the connections k and l are reversed or there is a feedback into the supply network.



WARNING

Material damage due to disregard of the connection instructions!

Voltages and currents outside the permissible measuring range can destroy the device.

Comply with the measuring range specifications from the technical data.

13.7 Overrange

If the measuring range is exceeded, a warning appears in the device display, e.g. for the voltage, the warning "**Overvoltage**" with an indication of the voltage circuit.

The overrange message is displayed as long as the condition is present. Warnings can be acknowledged with button 5 *Alarms*. The measuring range is exceeded if at least one of the voltage or current measurement inputs lies outside its specified measuring range.

Limit values for overrange (200 ms effective values):

$$I = 6 A_{\text{rms}}$$

$$U_{\text{L-N}} = 600 V_{\text{rms}}$$

Overvoltage L1 11:34				
	Voltage	Current	Power	PF1
L1	0V	0.000A	0.00kW	< 1.00
L2	0V	0.000A	0.00kW	< 1.00
L3	0V	0.000A	0.00kW	< 1.00
L1..L3	50.00Hz	0.000A	0.00kW	< 1.00
Active energy		Reactive energy ind.		
L1..L3	0.0kWh		0.0kvarh	
Menu	Alarms			

Fig. Example warning message, overvoltage in phase L1.

i INFORMATION

If the measuring range is exceeded, please check your installation and connections. Comply with the connection conditions specified in the technical data.

13.8 Checking the time

To enable correct assignment of times to the measurement data records requires a correct specification of the time. Check and, if needed, correct the time and date settings in the **Configuration / System** menu (see section „12.6.2 Date/time“ on page 54).

13.9 Checking the power measurement

Short-circuit all current transformer outputs except one and check the indicated powers.

- The device must only display power in the phase with the current transformer input that is not short-circuited.
- If this is not the case, check the connection of the measured voltage and measured current.

If the amount of active power is correct, but the sign of the active power is negative, this can have two causes:

1. The connections S1(k) and S2(l) on the current transformer are reversed.
2. Active energy is returned to the grid.

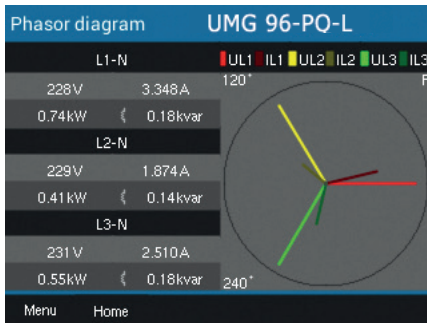

Fig. The phasor diagram shows voltages with long phasors and currents with short phasors.

Call up the phasor diagram with details on the power:

- If you are not in the start screen, you can go to this view by pressing button 2 (Home).
- Open the menu with button 1 (Menu).
- Use buttons 3 (▼) and 4 (▲) to select the item Voltage and confirm with button 6 (Enter).
- The submenu with the item *Phasor diagram* appears.
- Use buttons 3 (▼) and 4 (▲) to select the item *Phasor diagram* and confirm with button 6 (Enter).
- The *Phasor diagram* window appears.

13.10 Checking the communication

The device counts all received (RX), all sent (TX) and all faulty data packets.

Ideally, the number of errors in the Error column will be “0” (see figure below, window *Com. RS-485*).

- If you are not in the start screen, you can go to this view by pressing button 2 (Home).
- Open the menu with button 1 (Menu).
- Use buttons 3 (▼) and 4 (▲) to select the item *System Info* from the menu and confirm with button 6 (Enter).
- The following submenu appears:

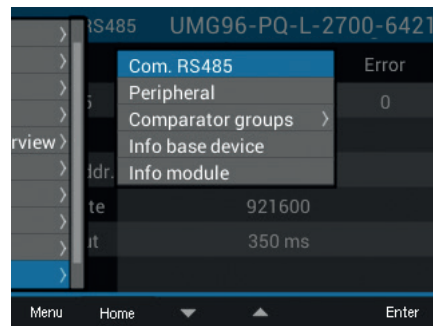

Fig. System Info submenu with activated entry *Com. RS-485*

- Use buttons 3 (▼) and 4 (▲) to select the submenu item *Com. RS-485* and confirm with button 6 (Enter).
- The *Com. RS-485* window appears with the parameters for the RS-485 communication interface.

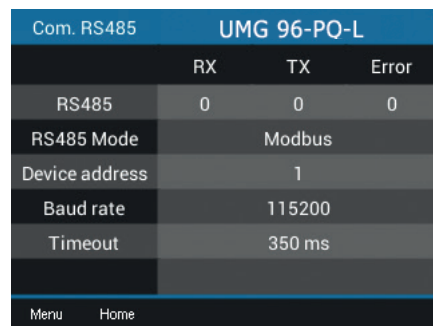

Fig. Display of the parameters that are set for the RS-485 communication interface.

Now check the RS-485 communication parameters, such as:

- All received (RX), all sent (TX) and all faulty data packets. Ideally, the number of errors in the column *Error* will equal "0".
- The mode that is set, the device address, baud rate and timeout.

Check the parameters of the measurement device to the digital inputs and outputs and the analog output as follows:

- If you are not in the start screen, you can go to this view by pressing button 2 (*Home*).
- Open the menu with button 1 (*Menu*).
- Use buttons 3 (▼) and 4 (▲) to select the item *System Info* from the menu and confirm with button 6 (*Enter*).
- The following submenu appears:

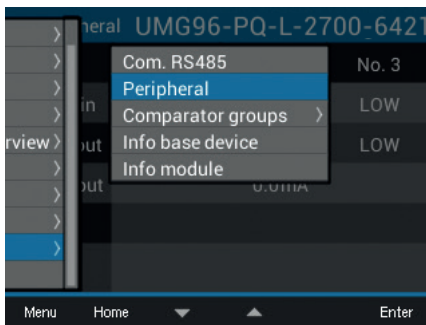

Fig. Submenu *System Info* with activated *Peripherals* entry

- Use buttons 3 (▼) and 4 (▲) to select the submenu item *Peripherals* and confirm with button 6 (*Enter*).
- The *Peripherals* window appears with the states of the digital inputs and outputs and the value of the analog output:

Peripheral		UMG 96-PQ-L		
I/O	No. 1	No. 2	No. 3	
Digital in	LOW	LOW	LOW	
Digital out	LOW	HIGH	LOW	
Analog out	0.0mA			
Menu Home				

Fig. Displays the states of the digital inputs and outputs and the value of the analog output.

13.11 Delete min./max. values

In the measuring displays for voltage, current and power, the device offers the function of deleting *Min./Max. values* using button 6 (Enter). The *Min./Max. values* can be deleted for the following measured values:

In the submenu **Voltage:**

- Voltage L-N
- Voltage L-L
- THD U (Total Harmonic Distortion - voltage)

In the window **Current:**

- Current
- THD I (Total Harmonic Distortion - current)
- TDD I (distortions with reference to nominal current)

In the window **Power:**

- Total power
 - Active power
 - Reactive power
 - Apparent power
- If you are not in the start screen, you can go to this view by pressing button 2 (Home).
 - Open the menu with button 1 (Menu).
 - Use buttons 3 (▼) and 4 (▲) to select the item Voltage, Current or Power and confirm with button 6 (Enter).

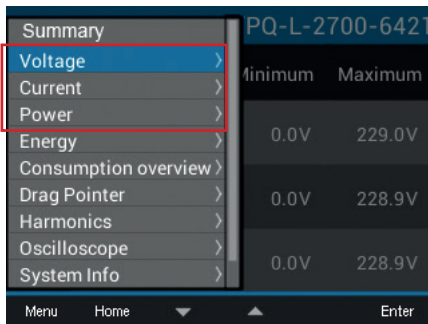

Fig. Voltage, current and power menus

The following description explains the *Delete min./max. values* function using the example of the measuring display *Voltage L-N*. Deleting the *Min./Max. values* for current and power requires the same procedure.

- The submenu for *Voltage* appears.
- In the submenu, select the item *Voltage L-N* with buttons 3 (▼) and 4 (▲) and confirm with button 6 (Enter).
- The voltage measuring display appears with the measured values L1-N, L2-N and L3-N.
- To delete the *Min./Max. values*, press button 6 (Enter).
- The *Min./max. values* submenu appears.
- In the *Min./Max. values* submenu, use buttons 3 (▼) and 4 (▲) to select the item *Delete* or end the action with the item *Cancel*.
- Confirm your action by pressing button 6 (Enter).

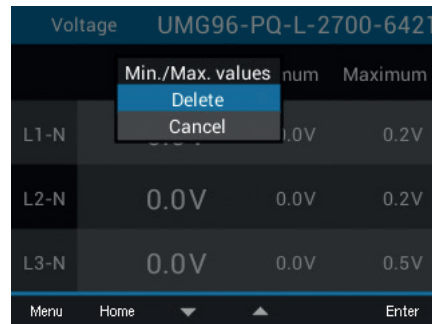

Fig. Measuring display, voltage L-N with menu Delete/Cancel min./max. values

13.12 Harmonics current (harmonics)

Harmonics current (harmonics) are caused, for example, by equipment with non-linear characteristics. These additional frequencies represent the integral multiple of a fundamental oscillation and show how the equipment affects the mains. Possible effects of harmonics are, for example:

- Additional heating of operating equipment.
- An additional current on the neutral conductor.
- An overload and a reduced service life of electrical consumers.

Harmonic loads are the main cause of invisible power quality problems involving enormous costs for repair and investment for the replacement of defective equipment.

The device measures the fundamental oscillation of the voltage in the range of 45 - 65 Hz. The calculated harmonics of the voltages and currents refer to this fundamental oscillation.

The measurement device calculates harmonics up to 65 times the fundamental oscillation.

- If you are not in the start screen, you can go to this view by pressing button 2 (*Home*).
- Open the menu with button 1 (*Menu*).
- Use buttons 3 (▼) and 4 (▲) to select the item Harmonics and confirm with button 6 (*Enter*).
- A selection list appears with voltage and current.
- Use buttons 3 (▼) and 4 (▲) to select Voltage, for example, and confirm with button 6 (*Enter*).
- A further selection list appears with the entries L1, L2 and L3.
- Use buttons 3 (▼) and 4 (▲) to select the respective phase (e.g. L1) and confirm with button 6 (*Enter*).
- The *Harmonics* window of the selected measured value appears.

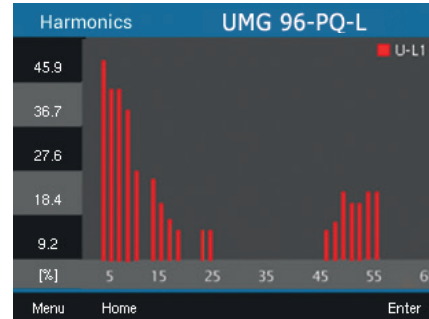

Fig. Measuring display for harmonics (e.g. Voltage L1)

13.13 Communication in the bus system

13.13.1 RS-485

The device sends and receives data via the RS-485 interface. For example, the device receives data from the parameter and measured value list via a MODBUS RTU protocol with CRC check.

Modbus functions (slave device)

02 Read Input Status
 03 Read Holding Registers
 04 Read Input Registers
 06 Preset Single Register
 08 Diagnostic Function
 16 (10Hex) Preset Multiple Registers
 23 (17Hex) Read/Write 4X Registers

The order of the bytes is high before low byte (Motorola format).

Transmission parameters

Data bits:	8
Parity:	odd
	even
	none (1 stop bit)
	none (2 stop bits)
Stop bits (device):	1 / 2
External stop bits:	1 / 2
Number formats	
short	16-bit ($-2^{15} .. 2^{15} - 1$)
float	32-bit (IEEE 754)

Further information can be found at the following locations:

- For connections and PC connection of the device via the interface, see section "8.2 RS-485 interface" on p. 35.
- For configuration of the RS-485 interface on the device, see section „12.3 Communication“ on page 45.
- For the Modbus functions, see the document "Modbus address list and formulary" for the measurement device. It is available in the download area of the homepage.

Example: Reading the voltage L1-N

The voltage L1-N is located in the list of parameters and measured values at address 19000 in the FLOAT format.

In this example 01 is assumed as the device address.

The "Query Message" then looks as follows:

Designation	Hex	Comment
Device address	01	Address=1
Function	03	"Read Holding Reg"
Start address Hi	4A	19000dec = 4A38hex
Start address Lo	38	
No. of values Hi	00	2dec = 0002hex
No. of values Lo	02	
Error check (CRC)	-	

The "response" of the device can then look as follows:

Designation	Hex	Comment
Device address	01	Address=1
Function	03	
Byte counter	06	
Data	00	00hex = 00dec
Data	E6	E6hex = 230dec
Error check (CRC)	-	

The voltage L1-N sent from address 19000 is 230 V.

13.14 Digital inputs/outputs

The measurement device has three digital outputs and three digital inputs.

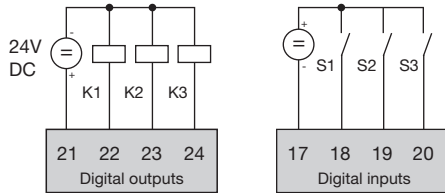

Fig. Digital outputs and inputs

- You configure the digital inputs and outputs using the GridVis® software
- The GridVis® software is available for download from our website (www.janitza.com).

13.14.1 Digital inputs

The measurement device can receive pulses from other devices that have a digital output (pulse counter, S0 input) via the digital inputs. Alternatively, you can assign a special function to each digital input. A function input **cannot** be used simultaneously as a pulse counter.

The digital inputs can be configured in the GridVis® software in the configuration window under *Peripherals*.

The states of the digital inputs each have their own Modbus address. For each digital input, the last 16 switching actions (events) are logged with a time stamp.

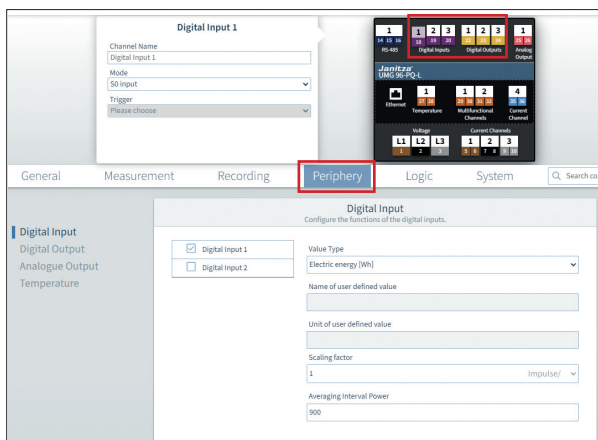

Fig. Configuration of the digital inputs via the GridVis® software

Function mode (*Mode*)

A separate function can be assigned to each digital input:

- Digital input 1:
 - S0 input (pulse counter)
 - Tariff switching (HT/NT)
 - External event recording
- Digital input 2:
 - S0 input (pulse counter)
 - Synchronization of the device clock with the selection Minutes or Hours synchronization (pre-configured pulse counters for minutes or hours). Alternatively, the time can be synchronized via Modbus addresses (see section „13.21 Time synchronization“ on page 93).
 - External event recording
- Digital input 3:
 - S0 input (pulse counter)
 - Reset input for the synchronous values of the drag indicator function. The synchronization of the drag indicator is also possible via a Modbus address.
 - External event recording

Pulse counter (*S0 input*)

- Value type of the incoming signal (e.g. electrical energy, gas/water consumption, CO₂ ...)
- Pulse valency for measured or power values.
- Length of the averaging time.

13.14.2 Pulse counter (S0 input)

All digital inputs can be operated with a frequency of 25 Hz. The pulse duration (pulse width) and the pulse pause must be greater than 20 ms. The typical pulse duration for S0 pulses is 30 ms.

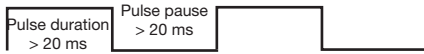

The maximum number of pulses per hour is calculated based on the minimum pulse duration and the minimum pulse pause:

Pulse length (pulse duration)	Pulse pause (pulse pause)	Max. pulses/h
20 ms	20 ms	90000 pul./h
30 ms	30 ms	60000 pul./h
50 ms	50 ms	36000 pul./h
100 ms	100 ms	18000 pul./h
500 ms	500 ms	3600 pul./h
1 s	1 s	1800 pul./h
10 s	10 s	180 pul./h

Tab. Examples of the maximum number of pulses per hour.

The pulse counters can be configured with simultaneous measured-value or power calculation. The pulses are counted as a 64-bit number and will overflow after approx. 1.17×10^{10} years of continuous operation (25 Hz).

Pulse valency

A pulse valency can be assigned to each digital input. With the pulse valency you specify which measured value or power value (e.g. energy) should correspond to one pulse.

***i* INFORMATION**

The pulse interval is proportional to the power within the selected settings.

Measured value calculation:

$$\text{Measured value} = \text{pulse} \times \text{pulse valency}$$

Power value calculation:

$$\text{Power value} = \frac{\text{Pulse} \times \text{pulse valency}}{\text{Time [s]}}$$

Since the pulse interval can be very large, continuous calculation of the measured or power values is not possible. Consequently, only average values are calculated. The calculation of the average values for the measured value calculation results from the number of pulses per period multiplied by the pulse valency. For the calculation of the mean power values, this value must be divided by a configurable time value.

The period is assigned to the respective digital input and can be set to between 1 and 60 minutes. After the period has expired, the value can be called up via Modbus.

An external synchronization can be connected for each digital input, whereby one synchronization pulse completes a period and starts a new one. A capture time of 30 seconds is permanently preset for the external synchronization. If there is still no synchronous pulse after the period has expired, the software waits a maximum of 30 seconds and then synchronizes. All further periods are then synchronized by the software.

A period of 15 minutes is set at the factory.

The calculation result of the S0 power value is only available at the end of the period.

***i* INFORMATION**

A selection of energy values derived from power values is available in the GridVis® software for the purpose of configuring the pulse counters.

13.14.3 Digital outputs

Different functions can be assigned to the 3 digital outputs:

- Digital output 1¹⁾
 - Pulse output for active energy
 - Output for a comparator group 1-5
 - Output for a timer switch
 - Modbus remote output
- Digital output 2
 - Pulse output for inductive reactive energy
 - Output for a comparator group 1-5
 - Output for a timer switch
 - Modbus remote output
- Digital output 3
 - Output for a comparator group 1-5
 - Output for timer switch
 - Modbus remote output

In the GridVis[®] software, you can define the digital outputs in the configuration window under *Peripherals*:

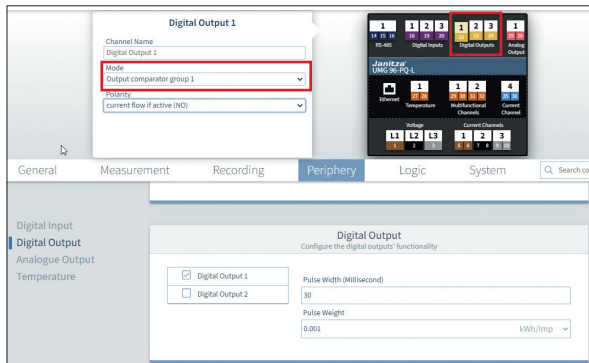

Fig. Configuration of the digital outputs via the GridVis[®] software

13.14.4 Pulse output

Digital outputs 1 and 2 can be used to output pulses for measuring active energy and reactive energy. To do so, a pulse is applied to the output after a certain, configurable amount of energy has been reached.

Configuring the pulse output

To use a digital output as a pulse output requires that various settings be made in the configuration window using the GridVis[®] software:

To use a digital output as a pulse output, configure your parameters in the configuration window of the GridVis[®] software:

- Pulse width
- Mode for the digital input: S0 output
- Output polarity: Normally open, normally closed
- Pulse valency

Pulse valency

The pulse valency indicates how much energy (Wh or varh) corresponds to one pulse.

The pulse valency is determined by the maximum connected load and the maximum number of pulses per hour.

i INFORMATION

Since the **Active energy meter** operates with a reverse running stop, the device only sends pulses when electrical energy is consumed.

Since the **Reactive energy meter** operates with a reverse running stop, the device only sends pulses when there is an inductive load.

Determine pulse valency

1. Set the pulse length according to the requirements of the connected pulse receiver. With a pulse length of 30 ms, for example, the device can emit a maximum of 60,000 pulses (see "8.4 Termination resistors" on p. 37) per hour.

2. Determine the maximum connected load:

Example:

- Current transformer = 150/5 A
- Voltage L-N = max. 300 V

- Power per phase = 150 A x 300 V = 45 kW

- Power with 3 phases = 45 kW x 3
- Max. connected load = 135 kW

3. Calculate pulse valency:

$$\text{Pulse valency} = \frac{\text{Max. connected load}}{\text{Max. number of pulses/h}} \quad [\text{Wh/pulse}]$$

Pulse valency = 135 kW / 60000 pulses/h
 Pulse valency = 0.00225 kWh/pulse
 Pulse valency = 2.25 Wh/pulse

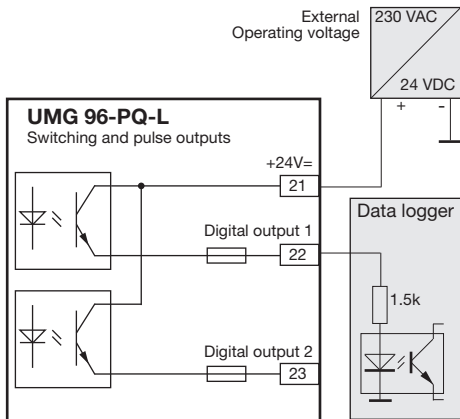

Fig. Connection example for wiring as a pulse output.

CAUTION

Measurement error when used as a pulse output.
 When the digital outputs are used as pulse outputs, measurement errors can occur due to residual ripple.
For the supply voltage of the digital inputs and outputs, use a power supply whose residual ripple is less than 5% of the supply voltage.

13.14.5 Modbus remote output

The value of a Modbus register is used to switch the assigned digital output.

Configure the digital outputs as Modbus remote outputs in the GridVis® software as follows:

- Open the device configuration in GridVis®.
- Set the mode of the digital outputs to *Modbus Remote Output* under *Peripherals*.
- Specify the output polarity with:
 - Current flow active (normally open contact)
 - Current flow inactive (normally closed contact)

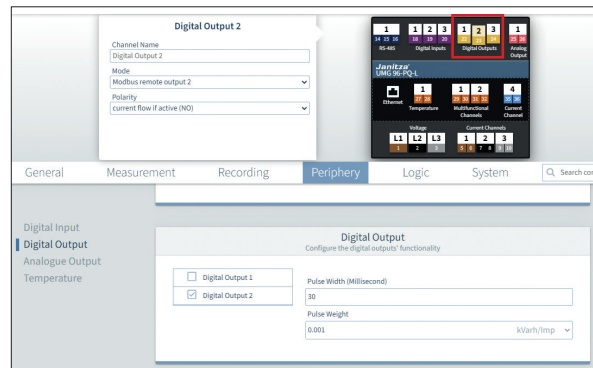

Fig. Configuration of the digital outputs as "Modbus Remote Output" in the GridVis® software

13.14.6 Timer switch output

Timers, e.g. for switching digital outputs, can only be set in the GridVis® software under *Management* > *Scheduling*.

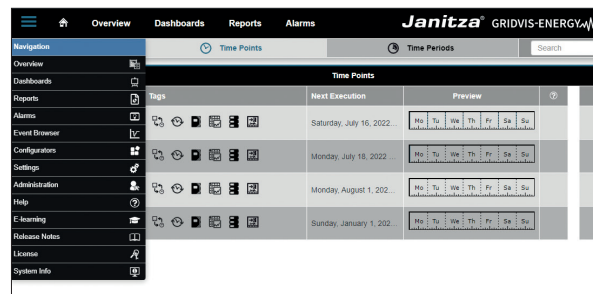

Fig. Timer setting (GridVis® software)

13.14.7 Comparator

Five comparator groups (*Comparator groups*) with 10 comparators each (A - J) are available for monitoring limit values.

You can link the results of the individual comparators A to J with "AND" or "OR". You can assign the result of a comparator group to one of the three digital outputs.

To configure the comparators, use only the configuration window in the GridVis® software under *Logic > Comparator*.

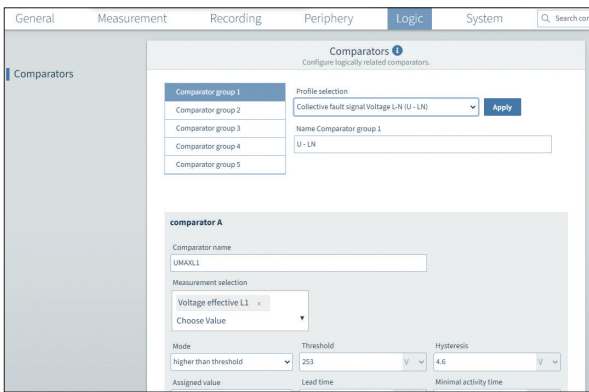

Fig. Configuration of the comparators in the GridVis® software

The preset profiles in the GridVis® software simplify the configuration of the comparators. You can assign one name to each comparator (max. 7 digits), e.g. "UMAXL13" for the phase-to-phase voltage L1-L3.

Reading out comparator settings on the device:

- Open the menu with button 1.
- Use buttons 3 (▼) and 4 (▲) to select the item *System Info*.
- Confirm using button 6 (Enter).
- The submenu appears.
- Use buttons 3 (▼) and 4 (▲) to select the item *Comparator groups*.
- Confirm using button 6 (Enter).
- Select a comparator group using buttons 3 (▼) and 4 (▲).
- Confirm using button 6 (Enter).

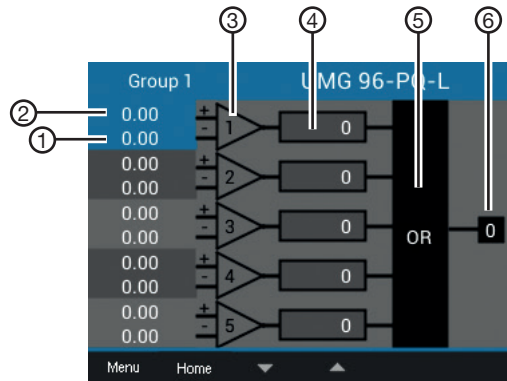

Fig. Display of comparator group 1 ("System Info > Comparator groups" menu)

Item	Function/Designation
1	Actual value
2	Limit value
3	Comparator
4	Comparator running time
5	Logic
6	Result of the comparator group

Tab. Legend for the figure above

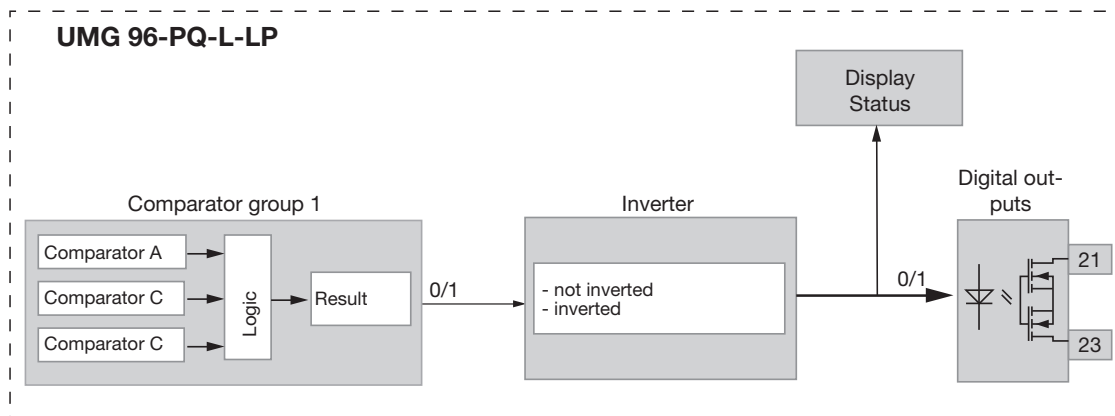

Fig. Block diagram "Using digital output 2 for limit value monitoring"

Comparator without hysteresis

- The set limit value is compared with the measured value.
- If there is a limit violation for at least the duration of the lead time, the comparator result is changed.
- The result is retained at least for the duration of the minimum activity time and at most for the duration of the limit violation. If there is no longer a limit violation and the minimum activity time has expired, the result is reset.

Comparator running time

The comparator running time is a time counter for each comparator that adds up the total time that the comparator output was set to active. This means that if the condition of the comparator is fulfilled and the lead time has expired, the counter increases by the corresponding amount of time. The minimum activity time (minimum initialization time) is taken into account here.

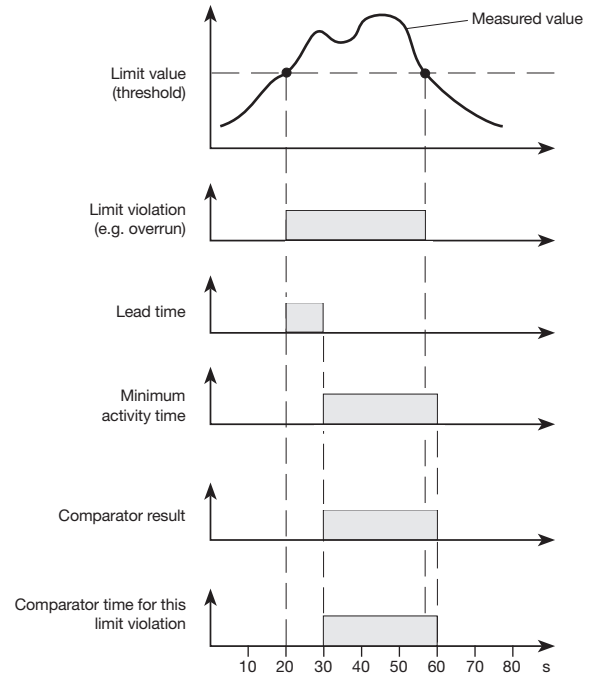

Fig. Comparator without hysteresis
Example with 10 s lead time and 30 s minimum activity time

Comparator with hysteresis

With the hysteresis in %, the switching off of the comparator can be delayed (as with an event).

Example: In the "above threshold" mode, the momentary measured value must again fall below the threshold value minus the hysteresis in order to change the output of the comparator.

Recording events (as of FW3.50)

Comparators are not only useful for setting digital outputs. Group 1 and 2 comparators can also start event recording when a threshold value is exceeded or undershot (see section „13.19 Events“ on page 87).

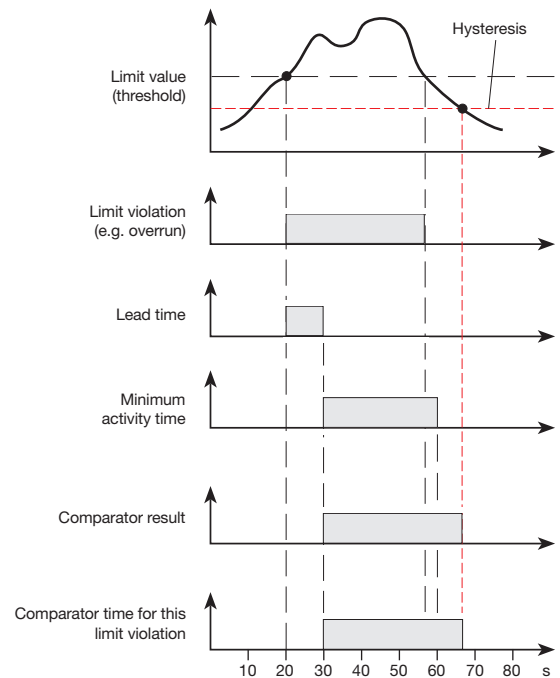

Fig. Comparator with hysteresis
Example with 10 s lead time and 30 s minimum activity time

13.15 Configuration of the analog output

The device has an analog output that can output a maximum current of 20 mA.

An external 24 VDC power supply unit is required for operation.

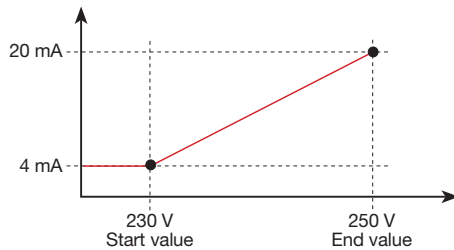

Fig. Principle of analog output with voltage monitoring

The configuration of the analog output can be carried out in a user-friendly manner using the GridVis® software. To do so, enter the assigned measured value, the start and end value and the output range in the device configuration under *Peripherals*.

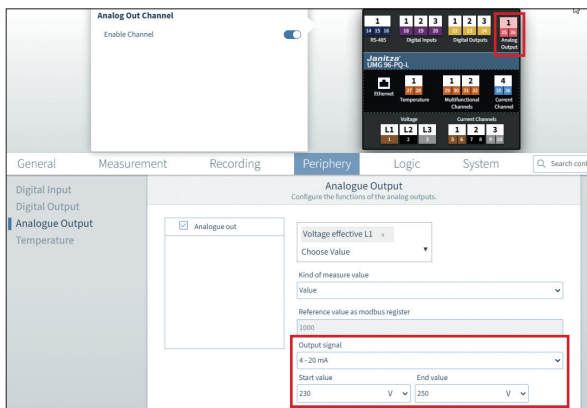

Fig. Configuration of the analog output in the GridVis® software

i INFORMATION

Information on configuring the analog output via the device keyboard can be found in section „12.7 Modbus editor“ on page 57.

Examples:

Assignment of active power L1 (output range 4 - 20 mA):

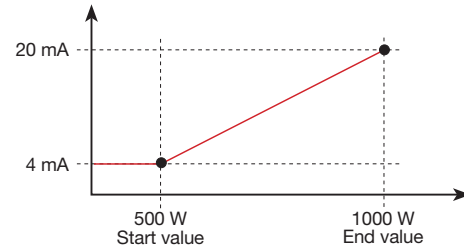

- With an active power of 500 W, the current at the analog output is 4 mA; with an active power of 1000 W --> 20 mA.

The measured active power is proportional to the current at the analog output.

Assignment of the calculated active power factor $\cos \varphi$ (math.) (output range 4 - 20 mA):

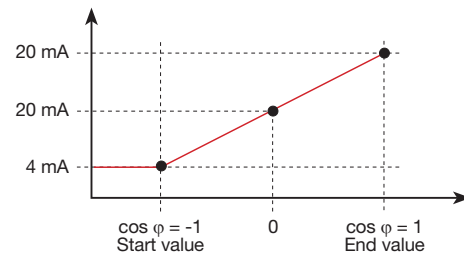

- Monitoring of the active power factor $\cos \varphi$ (math.) with:
 $\cos \varphi$ (math.) > 0 active power, consumed
 $\cos \varphi$ (math.) < 0 active power, delivered.

13.16 Drag indicator function

The "Drag indicator" function captures the 3 highest average values over a defined period (time base).

- The device displays the measured maximum average values in the Drag Indicator menu (see section „13.16.4 Drag indicator - Measurement device displays“ on page 80).
- The average values determined can be called up via the GridVis® software and via a parameter with a time stamp.
- The period duration (time base), synchronization and capture time can be set in the GridVis® software or by setting the corresponding parameters.
- The average value calculation is made from the measured values of the following value types:
 - Current L1
 - Current L2
 - Current L3
 - Active power L1
 - Active power L2
 - Active power L3
 - Active power sum (L1...L3)
 - Apparent power L1
 - Apparent power L2
 - Apparent power L3
 - Apparent power sum (L1...L3)

Period duration (time base):

Individually configurable period duration in seconds for the calculation of the average values over this period (duration of measured value recording). If internal synchronization is selected, the average values are recalculated after the set period of time has elapsed.

Synchronization mode:

A synchronization determines a start time for the calculation periods of the average values.

- You can optionally start a synchronization via:
- the internal device clock (*internal synchronization*);
 - the setting of a parameter (*via Modbus*);
 - digital input 3 (*external synchronization*).

Capture time:

The individually configurable *Capture time* describes a time window in which an incoming pulse synchronizes the point in time. If the device receives a pulse outside the capture time, the calculated average values are deleted and the time is reset.

Note: The setting for the capture time – e.g. in the GridVis® software – describes half the time window of the total capture time!

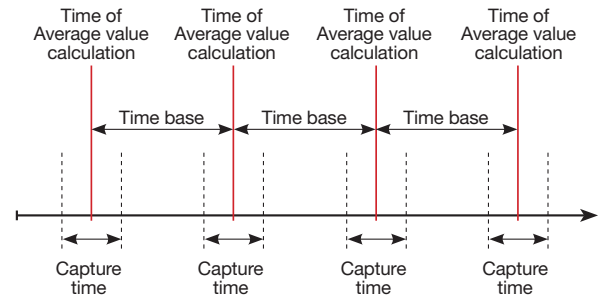

Fig. Principle of synchronization

13.16.1 Internal drag indicator synchronization

The average values are calculated after the configurable period of time (time base) has expired. The internal synchronization takes place at the full minute if this is a multiple of the time base.

Time base [min]	Sync 1 (time)	Sync 2 (time)	Sync 3 (time)	Sync 4 (time)
2	09:00:00	09:02:00	09:04:00	09:06:00
5	09:00:00	09:05:00	09:10:00	09:15:00
15	09:00:00	09:15:00	09:30:00	09:45:00

Tab. Examples of internal synchronization with different time bases

ⓘ INFORMATION

For an *internal synchronization*, the options *Synchronization via Modbus* **AND** *Synchronization via digital output 3* must both be deactivated!

13.16.2 External drag indicator synchronization

An external synchronization for the calculation of the 3 highest average values is performed:

- via digital input 3 (e.g. via a pulse generator) or
- via a Modbus command.

External synchronization scenarios:

"No pulse despite setting"

If there is no pulse via digital input 3 or a Modbus command, the measured values are stored as with an internal synchronization – but not only at each full minute!

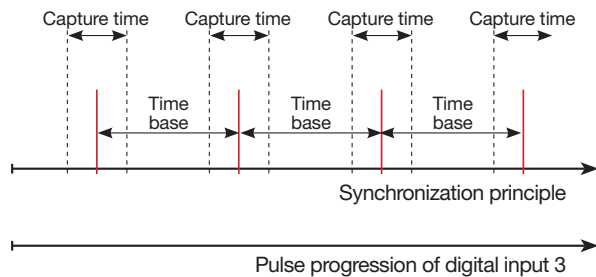

Fig. Principle of synchronization with "No pulse despite setting"

"One pulse"

If the device receives a pulse or a Modbus command once outside the capture time, the measured values added up to that point are reset for the calculation of the average value and the time. The time is redefined as a relative zero point and a new calculation is performed!

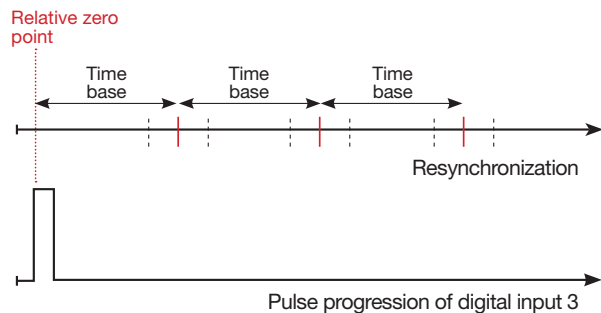
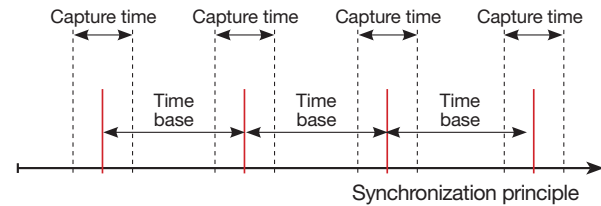

Fig. Principle of synchronization with "One pulse outside the capture time"

Example:

Example	Maximum value	Value	Time stamp
Effective current L1	Drag indicator 1	3.51 A	09:13:07
Effective current L1	Drag indicator 2	2.52 A	09:08:07
Effective current L1	Drag indicator 3	1.52 A	09:03:07

Tab. Example of drag indicator storage with a time stamp (with set time base of 5 min)

Example	Maximum value	Value	Time stamp
Active power L1	Drag indicator Consumption 1	396.73 W	09:18:47
Active power L1	Drag indicator Consumption 2	207.34 W	09:13:47
Active power L1	Drag indicator Consumption 3	80.59 W	09:08:47

Tab. Example of drag indicator storage with a time stamp (with set time base of 5 min)

The power increases with time. The values are reset to 0 by the pulse (09:06:47) outside the capture time. A new summation of the intermediate values begins from this point on. As no further impulse is received, the average value is calculated after the set time (time base).

“Periodic pulses”

If the device receives periodic pulses via digital input 3 or periodic Modbus commands, there are different scenarios.

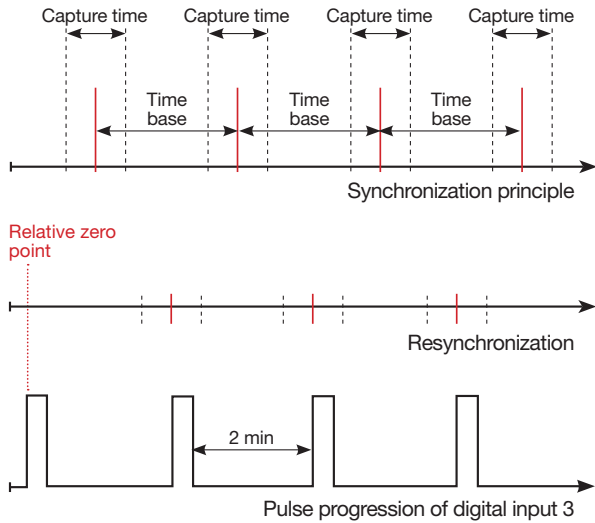
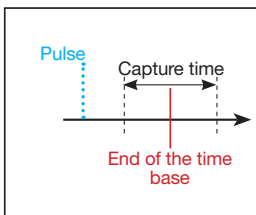

Fig. Principle of synchronization with “periodic pulses” to digital input 3

Scenario “Pulse outside the capture time”:

- Summed intermediate values are set to 0.
- The time is set to 0 (new relative zero point).
- There is no value calculation.



Scenario “Pulse after time base, but within the capture time”:

- Summed intermediate values are set to 0.
- The time is set to 0 (new relative zero point).
- There is no value calculation.

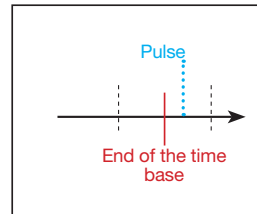

Scenario “Pulse before time base, within the capture time”:

- Perform value calculation now.
- The time is set to 0 (new relative zero point).
- Delete summed intermediate values.

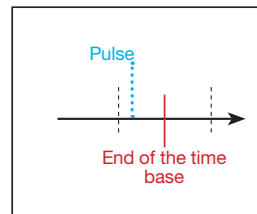

ⓘ INFORMATION

With periodic synchronization, the time is synchronized with each pulse!

13.16.3 Configuring the drag indicator synchronization

The synchronization determines a start time for the calculation periods of the drag indicator average values.

There are 3 types of synchronization, which have the following priority internally in the device. Select one of them:

- **Priority 1: Modbus synchronization**

In the configuration window in the GridVis® software under *General > Drag indicator*, select the option *Synchronization via Modbus*.

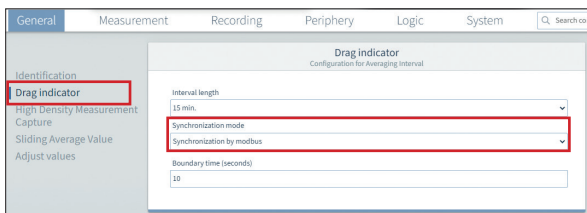

Fig. Drag indicator configuration in the GridVis® software

Alternatively, set the "Enable flag" via the Modbus tool (Addr.: 822).

- **Priority 2: Synchronization via digital input 3**

In the GridVis® software, in the configuration window for digital input 3, select the option *Drag indicator synchronization*.

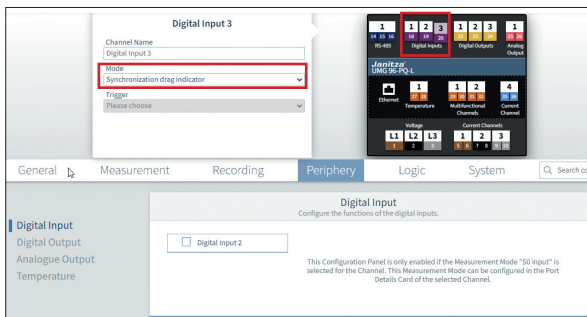

Fig. Synchronization of the drag indicator via digital input 3

- Alternatively, set the Modbus parameter for digital input 3 (addr. 30048) to the value 4 for drag pointer synchronization.

Modbus address	Function	Setting range
820	Set trigger flag for drag indicator synchronization	0 / 1
821	Time base in seconds	60 .. 65535
822	Drag pointer synchronization via Modbus: no/yes (enable flag)	0 / 1
823	Capture time in seconds	0 .. 255
30048	Configuration of digital input 3	
	· Off	0
	· Drag indicator synchronization	4
	· Start event recording with rising/falling/any edge	5 / 6 / 7

Tab. Modbus addresses for synchronization

- **Priority 3: Internal synchronization**

In the configuration window in the GridVis® software under *General > Drag indicator*, select the option *Internal synchronization* only if no synchronization via Modbus or digital input is desired.

i INFORMATION

Recommendation: Only activate one type of drag indicator synchronization. If several types are activated, only the type with the highest priority is effective.

For an *internal synchronization*, the options *Synchronization via Modbus* **AND** *Synchronization via digital output 3* must both be deactivated!

13.16.4 Drag indicator - Measurement device displays

As already described in the section „Drag indicator function“ on page 76, the drag indicator function shows the **3 highest average values of value types over a defined period (time base).**

The drag indicators of the respective measured value types can be called up on the measurement device display under *Menu > Drag indicator*. To do so, proceed as follows:

- If you are not in the start screen, you can go to this view by pressing button 2 (*Home*).
- Open the menu with button 1 (*Menu*).



Fig. Drag indicator menu item

- Use buttons 3 (▼) and 4 (▲) to select the item Drag indicator and confirm with button 6 (*Enter*).
- The submenu with the entries *Current*, *Active power* and *Apparent power* appears.



Fig. Drag indicator display with the submenu items *Current*, *Active power* and *Apparent power*.

- Use buttons 3 (▼) and 4 (▲) to select, for example, the item **Current** and then in the drop-down menu, for example, the item **L2**.

- Confirm using button 6 (*Enter*).
- The *Current L2* window appears with the following measured values:

Current L2		UMG 96-PQ-L	
Drag Pointer	Value	Date & Time	
1.	5.033A	27.07.20	11:38
2.	4.158A	27.07.20	11:40
3.	3.825A	27.07.20	11:37
Menu Home Delete			

Fig. Drag indicator display - Current L2 (effective) – of the last 3 maximum values with a time stamp.

In addition to the drag indicators of the **Currents L1, L2, L3**, the measurement device also shows you the drag indicators for **Active power** (applied and delivered) and **Apparent power - individually for phases L1, L2, L3 and for the totals L1 - L3.**

Active power Σ		UMG 96-PQ-L	
Drag Pointer	Value	Date & Time	
1. Con.	3487W	27.07.20	11:38
2. Con.	2886W	27.07.20	11:40
3. Con.	2201W	27.07.20	11:37
1. Del.	1395W	27.07.20	11:43
2. Del.	1395W	27.07.20	11:44
3. Del.	1188W	27.07.20	11:42
Menu Home Delete			

Fig. Drag indicator display - active power sum (consumed and delivered) – of the last 3 maximum values with a time stamp.

Apparent pwr Σ UMG 96-PQ-L		
Drag Pointer	Value	Date & Time
1.	3487VA	27.07.20 11:38
2.	2886VA	27.07.20 11:40
3.	2201VA	27.07.20 11:37
Menu Home Delete		

Fig. Drag indicator display - Apparent power sum - of the last 3 maximum values with a time stamp.

13.16.5 Delete drag indicator

In each drag indicator display of the device - current, active and apparent power - a dialog box for deleting the drag indicator values appears when button 6 is pressed:

Active power Σ UMG 96-PQ-L		
Drag Pointer	Value	Date & Time
1. Con.	0.000W	14.07.20 10:50
2. Con.	0.000W	22.08.20 14:15
3. Con.	0.000W	22.08.20 14:55
1. Del.	0.000W	14.07.20 10:50
2. Del.	0.000W	22.08.20 16:15
3. Del.	0.000W	22.08.20 14:15
Menu Home <input type="button" value="Enter"/>		

Fig. Dialog box for deleting the drag indicator values

i INFORMATION

The deletion of current, active power or apparent power drag indicator values of one phase also causes the deletion of the drag indicator values for the other phases of the respective category. If, for example, you delete the drag indicator "Current" of phase L1, the device also deletes the drag indicator "Current" for phases L2 and L3!

13.17 Gridded and moving averages

The measurement device records average values for the measured voltages, currents and powers. The time interval for determining the mean value must be defined in the GridVis® software. The average values and the associated 200 ms minimum and maximum values can be read out via Modbus addresses.

- **Gridded** averages (as of firmware 3.42) are calculated for a fixed time grid (averaging interval). The time grid always starts on the hour. With the factory setting of 15 min., the time intervals always start at the full hour, a quarter of an hour after, at the half hour and a quarter of an hour before the full hour. The gridded average values can be read out as of Modbus address 32000. Gridded averages allow you to evaluate the same time periods from several measurement devices that are synchronized.

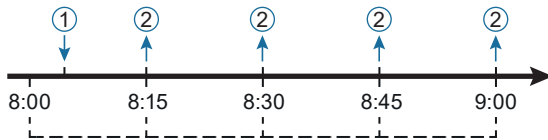

Fig. Gridded average values: 1) Switch on (start measurement); 2) New average value of the last 15 min time grid available

The current gridded average values can be displayed in the *Current* and *Power* menus.

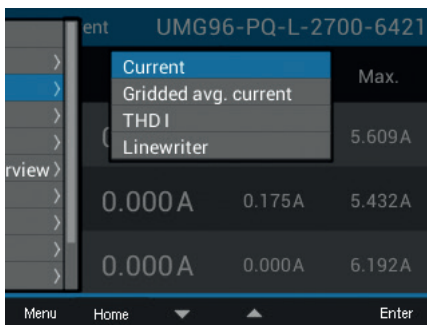

Fig. Current menu with gridded average values

- **Moving** averages always apply to the last elapsed time interval, starting from the current time. The average values are recalculated every minute. The averaging interval for moving averages is preset to 15 min. Example: When the values are queried at 10:18, the average values for the interval 10:03 to 10:18 are sent (accurate to the second for the last 900 s).

i INFORMATION

The meter overwrites the Modbus addresses with the average values and the associated minimum and maximum values for each interval, even if the previous values were not retrieved. For gridded and moving averages, the time stamp is provided in Modbus addresses (time and date in the DIN EN 60870 format) in addition to the measured values. The Address 32609 contains the time instant of the current gridded average value as a Unix time stamp (UTC time).

13.18 Recording measured values

You can configure measured value recordings for the measurement device easily and conveniently in the GridVis® software.

The default settings of the measurement device already include recording sets with integrated measured values for 2 separate partitions in the device memory:

- **Measured values partition A** = For long-term recording (up to 7 recording sets).
- **Measured values partition B** = For detailed recording, which can optionally be started by triggering (up to 7 recording sets).

More measured values can be added in the standard recording sets.

Further notes on configuration:

- The minimum averaging time for measured value recordings on measured values partition A is 60 s (default setting, 600 s).
- The minimum averaging time for measured value recordings on measured values partition B is 3 s (default setting, 600 s).
- The measurement device allows 7 recordings per partition with 30 measured values each.

• Within the recording configuration, measured values are defined via a time interval according to the types *Average*, *Sample*, *Maximum* and *Minimum*:

- *Average value* type: Arithmetic mean of the measured values over the specified time interval.
- Type *RMS*: Root-mean-square value of the measured values over the specified time interval.
- *Maximum* and *Minimum* type: Maximum or minimum values in the time interval.
- *Sample* type: Measured value (instantaneous value) at the end of the specified time interval.

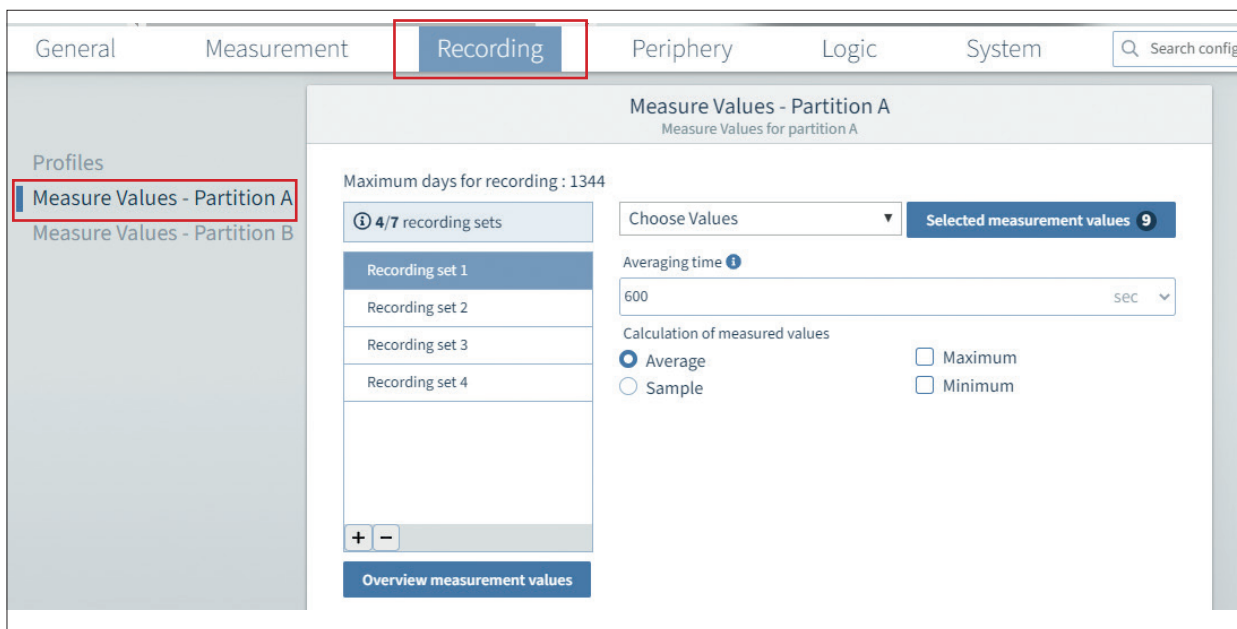

Fig. Recording configuration of measured values partition A in the GridVis® software

The following sections show the recording sets configured in the default setting. A detailed description of the measured value recordings can be found in the online help of the GridVis® software.

13.18.1 Default setting, Partition A

The measurement device uses measured value partition A for recording measured values relevant for energy management systems. The measured values are recorded continuously in partition A (24 h a day, 7 days/week).

Recording set 1 (9 measured values)

The measurement device calculates the following arithmetic mean values from the continuously recorded measured variables over an interval of 600 seconds and records them.

Preset recording set 1 (600 s)	
RMS voltage	L1
	L1-L3
	L2
	L2-L1
	L3
Voltage THD [%]	L3-L2
	L1
	L2
	L3

Recording set 2 (20 measured values)

The measurement device calculates the following arithmetic mean values from the continuously recorded measured variables over an interval of 600 seconds and records them.

Preset recording set 2 (600 s)	
Reactive power, fundamental oscillation	L1
	L2
	L3
	Sum L1..L3
Cos phi (math.)	L1
	L2
	L3
	Sum L1..L3
Apparent power	L1
	L2
	L3
	Sum L1..L3
RMS current	L1
	L2
	L3
	Sum L1..L3

Preset recording set 2 (600 s)	
Active power	L1
	L2
	L3
	Sum L1..L3

Recording set 3 (4 measured values)

At the end of an interval of 900 s, the measurement device records the instantaneous values for current and voltage (*Sample*) and calculates the work values for the recording by adding them up.

Preset recording set 3 (900 s)	
Active energy consumed, overall tariff	L1
	L2
	L3
	Sum L1..L3

Recording set 4 (8 measured values)

At the end of an interval of 3600 s, the measurement device records the instantaneous values for current and voltage (*Sample*) and calculates the work values for the recording by adding them up.

Preset recording set 4 (3600 s)	
Active energy consumed, overall tariff	L1
	L2
	L3
	Sum L1..L3
Inductive reactive energy, overall tariff	L1
	L2
	L3
	Sum L1..L3

13.18.2 Default setting, Partition B

The measurement device uses measured values partition B for recording measured values relevant for power quality.

You can control the recording in partition B using the GridVis software and this applies for all recording sets together:

1. Recording always active:

The measurement device records the selected measured values 24 hours a day, 7 days a week.

2. Event triggered recording

The meter starts recording when an event occurs and records the selected measured values for 15 min. If another event occurs during these 15 min, recording starts again. The event trigger can be external (digital input or Modbus) or internal (configured under *Measurement > Power quality*). This recording variant is recommended for recording event-relevant measured values with a low time base (see section „13.19 Events“ on page 87).

3. Manual Start/Stop for recording:

Start or stop the recording of the selected measured values with the Start/Stop button in the GridVis software in the area *Measured values partition B* or via Modbus register 533 (Start = value 1, Stop = value 2).

This recording mode is recommended for recording many measured values at a low time base over a certain period of time.

Partition B has 3 preset recording sets (configurable via the GridVis® software):

Recording set 1 to 3 (25 measured values each)

The measurement device calculates the following arithmetic mean values from the continuously recorded measured variables over an interval of 600 seconds and records them.

	Recording set		
	1	2	3
1st to 25th Voltage harmonics	L1	L2	L3

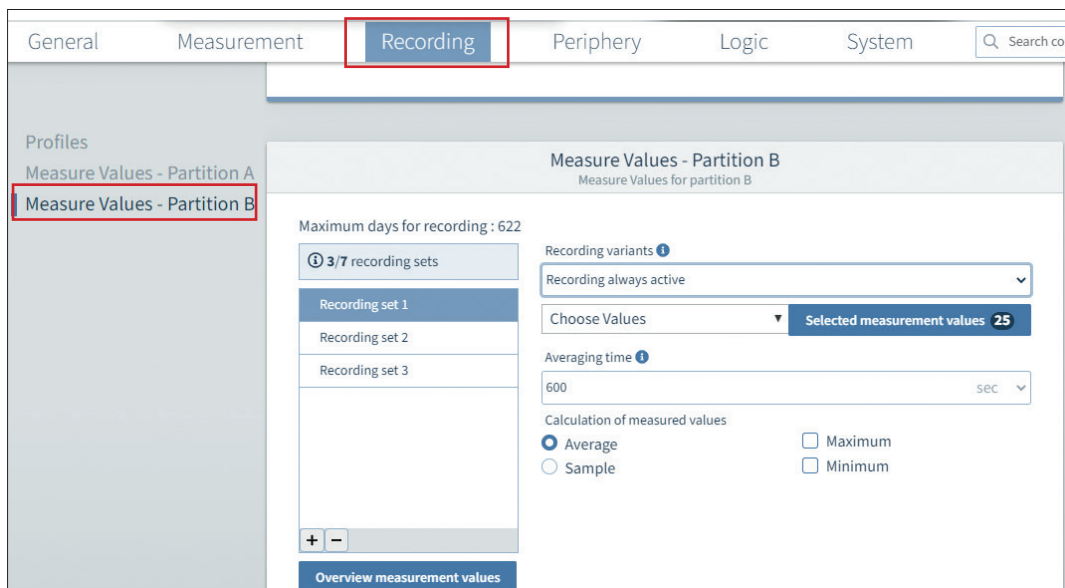

Fig. Recording configuration of memory partition B in the GridVis® software

13.18.3 Use cases – Recording examples

Use case 1

The meter is read out daily. Recording runs on both memory partitions 24 hours a day, 7 days a week. For example, the meter records the conventional measured values for energy management such as current, voltage, power, energy.

Use case 2

The meter is read out daily. In addition to the conventional measured values for energy management, measured values are to be recorded over specific time periods or on an event-driven basis with a low time base.

Application case 3

The meter is read out once a year (e.g. meters in distribution substations). The meter user uses both partitions in order to obtain a very high recording depth overall. This use case occurs, for example, with utilities that record for up to 4 years.

Application case 4

The meter is read out once a year (e.g. meters in distribution substations). For example, the meter user uses partition A for recording long-term data (approx. 1400 days) such as current, voltage, power, energy, THD and cos phi, plus partition B for PQ data such as the 1st - 65th harmonics (81 days). Thus, in addition to the recording of all long-term data, the meter user also has the PQ data for a possible error case retroactively for 81 days.

i INFORMATION

Take note when configuring the measured value recording:

The lower the averaging time that is set, the greater the volume of data in the respective partitions of the measurement device and in the database of the GridVis® software. In this regard, note the indication of "Recording duration in days":

- Long recording interval (e.g. 3600 s) = low data volume.
- Short recording interval (e.g. 600 s) = high data volume.

A full partition has a data volume of 24 MB, and a readout via the RS-485 interface can take several hours.

Recommendation: Use an Ethernet connection (RCM-EL module) for reading out large data volumes! Regular reading of your data does not require any action.

13.19 Events

The "Events" function helps when analyzing faults in the power or supply network. For each event, the meter starts a **Recording** of the measured values including lead and lag time before and after the event.



Fig. Submenu for displaying recorded events

Recorded events can be shown on the device display, but due to the display size, only with a short time segment of 2.5 s before and after the trigger time of the event.

The total recording time is 40 s (of which max. 20 s are lead time). 20 s each of lead time and lag time are preset. These times apply for a 50 Hz mains frequency – at 60 Hz it is 16.7 s of lead and lag time.

To display the total recording duration, use the Event Browser in the GridVis® software.

i INFORMATION

- The meter records the following during events:
- The full-wave RMS values for L1-L3 with a resolution of 20 ms.
 - The full-wave RMS values for L4-L6 (neutral or residual current, only with RCM module) with a resolution of 200 ms.
 - 204.8 sample points per full wave at 50 Hz and 170.6 sample points at 60 Hz.
 - The type of event, the duration, the deviation, the date and the RMS value.
 - 6000 events "Qualitatively" and 200 "Quantitatively" and shows them in the display.

The measurement device distinguishes between internal and external events:

13.19.1 Internal events

An internal event exists when set limit values are exceeded or undershot. When doing so, the meter compares the set limit values with the **full-wave RMS values** from the measuring channels.

When one of these events occurs, recording is started automatically:

- Voltage interruption (U_{off})
- Undervoltage (U_{min})
- Overvoltage (U_{max})
- Overcurrent (I_{max})
- Overcurrent I4 (I_{max})
- Residual current I5, I6 (only with RCM module)
- Comparator event

Comparator events

The result of a group 1 or 2 comparator can start an event recording, e.g. when the value falls below a threshold (see section „13.14.7 Comparator“ on page 73). You can configure comparator events in the GridVis® software under *Configuration > Logic > Comparator*.

You must configure the parameters for recording internal events exclusively in the GridVis® software (see section „13.19.3 Configuring events“ on page 89).

13.19.2 External events

You can also start ("trigger") an event recording using an external signal via:

- Modbus
- Digital inputs 1, 2 and 3.

Event logging via Modbus

When a Modbus event occurs, the meter starts sequence recording, which provides 20 ms values with a lead and lag time of 20 s each for the current and voltage.

You must trigger the external Modbus event in the GridVis® software or write a 1 to Modbus register 806.

The measurement device identifies an event via Modbus and displays it in the meter display with the trigger time:

All events		UMG 96-PQ-L	
Phase	Events	Date & Time	
---	MODBUS	21.10.21	07:59:36,489
---	MODBUS	21.10.21	07:59:29,801
---	MODBUS	21.10.21	07:59:29,000
---	MODBUS	20.10.21	12:51:28,947
L1..L3	UMAX	19.10.21	15:09:52,859
L3	UMAX	19.10.21	15:09:52,859

Fig. Event list – entries of the Modbus events.

Event logging via digital inputs

External devices (signal generators) can be used, for example, to detect voltage dips when loads such as capacitors, motors or similar with high starting currents or inrush currents are switched in to circuits.

In this case, the output of the external device must send a signal to a correspondingly configured digital input of the measurement device (cf. „9.1 Digital inputs“ on page 38).

The time stamp of the trigger time is also displayed in the event list:

Ext. Dig. In		UMG 96-PQ-L Test	
Phase	Value	Date & Time	
---	Dig. In. 3	26.10.21	15:50:11,532
---	Dig. In. 2	26.10.21	15:50:11,114
---	Dig. In. 1	26.10.21	15:50:11,114
---	Dig. In. 1	26.10.21	15:50:10,527
---	Dig. In. 2	26.10.21	15:50:10,519
---	Dig. In. 1	26.10.21	15:50:09,705

Fig. Event list – entries of the events on the respective digital input.

The trigger for the event can be the rising, falling or changing edge of the signal at the input.

You must configure the digital inputs in the Grid-Vis® software (mode: *External event recording*) or in the following Modbus addresses:

Digital input	Modbus address	Entry (short)	Start recording by
Dig. In. 1	30046	5	Rising edge
		6	Falling edge
		7	Changing edge
Dig. In. 2	30047	5	Rising edge
		6	Falling edge
		7	Changing edge
Dig. In. 3	30048	5	Rising edge
		6	Falling edge
		7	Changing edge

Tab. Modbus addresses for event recording via digital inputs

13.19.3 Configuring events

You must configure internal events exclusively in the GridVis® software under *Configuration > Measurement > Power quality*.

You can also configure comparator events in the GridVis® software, however under *Configuration > Logic > Comparator*.

Specify limit values and the hysteresis as a percentage of the nominal value for the detection of:

- Undervoltage
- Overvoltage
- Voltage interruption
- Overcurrent

The screenshot displays the configuration interface for the UMG 96-PQ-L device. The top section shows device details: Basic Device UMG 96-PQ-L, ID UMG96-PQ-L-2700-6421, and various system parameters like IP-Address (192.168.3.154), MAC-Address (00:0E:6B:0D:00:35), and Firmware (Core: 3.44). A navigation menu at the bottom includes General, Measurement, Recording, Periphery, Logic, and System. The 'Measurement' section is active, showing a sidebar with options like Nominal Values, Measurement Circuit, Current Transformer, Voltage Transformer, Residual Current, and Power Quality. The 'Power Quality' configuration page is open, showing a 'Voltage' event configuration. The nominal value is 230.0 V. Three event types are configured: Under voltage (threshold -15% = 195.5 V, hysteresis 2% = 4.6 V), Over voltage (threshold +10% = 253.0 V, hysteresis 2% = 4.6 V), and Voltage outage (threshold -100% = 0.0 V, hysteresis 0% = 0.0 V). Each event has a corresponding waveform icon and a toggle switch.

Fig. Configuration of the events in the GridVis software®

13.19.4 Event recording time

If an event has occurred, the measurement device records the associated measured value with 1000 full waves each as the lead and lag time. The length of the recording is therefore determined by the number of full waves. At 50 Hz, 1000 full waves correspond to the 20 s specified above. At 60 Hz, the lead and lag times are 16.7 s each.

Exception: If under *Recordings > Measured values Partition B* event-triggered recording is selected,

then the **Recording time is 15 min.** (see section „13.18.2 Default setting, Partition B“ on page 85).

If an event has not yet been completed at the end of the lag time, the measurement device starts another recording sequence at the end time of the event (cf. example 2). However, no sequence segment of the end time is shown on the meter display.

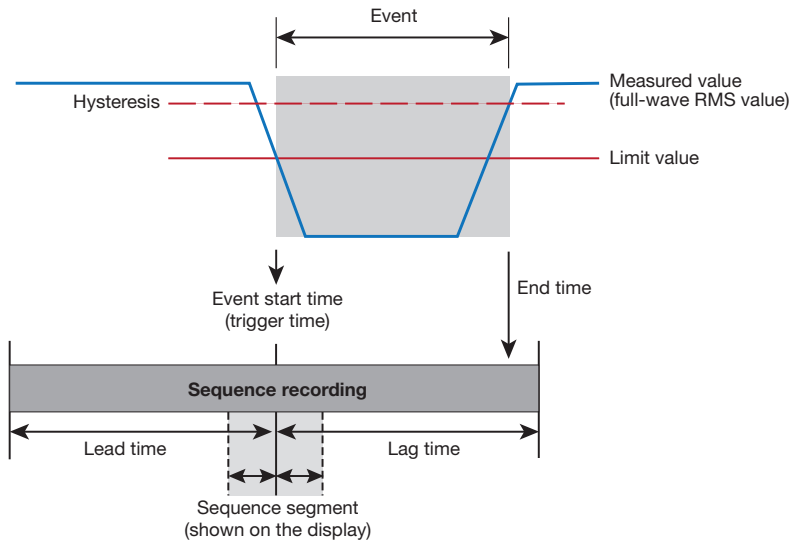

Example 1 of an event with a recording sequence (lead and lag time) and a sequence segment

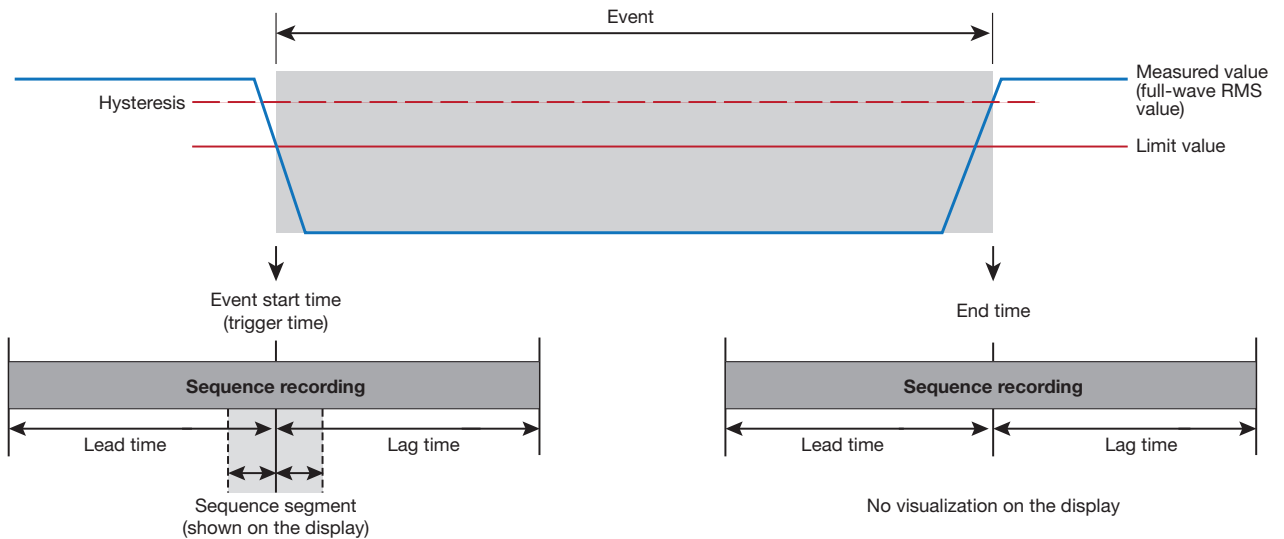

Example 2 of an event (> 20 s) with sequence recording (lead and lag time), sequence segment (displayed visualization) and sequence recording at the end time (lead and lag time)

13.19.5 Display of events

An overview of all events that have occurred is shown by the meter in lists for each event type. After selecting an event, the display shows a sequence segment of 2.5 s before and after the trigger time (cf. Example 1 on Page 90).

Proceed as follows to display and evaluate a specific event on the meter:

- If you are not in the start screen, you can go to this view by pressing button 2 (Home).
- Open the menu with button 1 (Menu).
- Use buttons 3 (▼) and 4 (▲) to select the item *Event* and confirm with button 6 (Enter).
- The submenu with the event lists appears.



Fig. Events submenu

- Use buttons 3 (▼) and 4 (▲) to select the event type, e.g. the item *All*.
- Press button 6 (Enter).
- The *All events* window appears with an indication of the phase, event type, date and time of all events.

All events		UMG96-PQ-L-2700-0035	
Phase	Events	Date & Time	
L1..L3	UMIN	11.10.21	17:25:18,508
L3	UMIN	11.10.21	17:25:18,589
L2	UMIN	11.10.21	17:25:18,589
L1	UMIN	11.10.21	17:25:18,589
L1..L3	UMAX	11.10.21	17:25:18,508
L3	UMAX	11.10.21	17:25:18,589

Fig. Event list with all events

- To display and evaluate an event, use buttons 3 (▼) and 4 (▲) to select the corresponding event (hold down button 3 (▼) or 4 (▲) to scroll).
- Confirm the selected list entry with button 6 (Enter).
- The window for evaluation of your event appears (in the example, the sequence of an undervoltage event U_{min}).

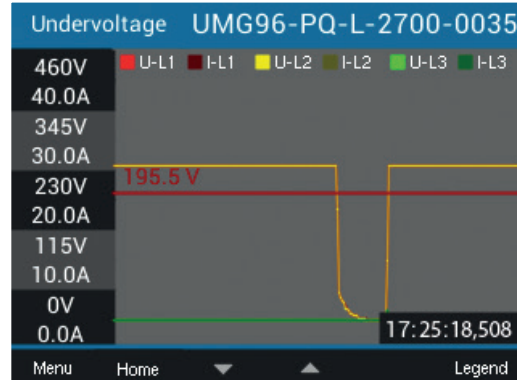

Fig. Sequence visualization of the undervoltage event

- Use button 6 (Legend) to show or hide the legend of the measuring channels.
- Use buttons 3 (▼) and 4 (▲) to switch the display to the previous or next event.
- Use button 1 (Menu) to go back through the displays step by step.

i INFORMATION

For better analysis, the GridVis® software visualizes recorded events in the event browser (Event Browser) and provides help on the events in the form of information texts and images. You can also retrieve the last completed event via Modbus-enabled third-party devices.

13.20 Tariff switching

The recording of electrical energy values (active, reactive and apparent energy) is done via internal meters for two tariffs each.

Switching between the tariffs (HT/LT) can be carried out via:

- Modbus
- Digital input 1
(see section „Digital inputs“ on page 69)

UMG 96-PQ-L			
Tariff	Active E. [kWh]	Reactive E. [kVAh]	Apparent E. [kVAh]
1	0	0	0
2	0	10	10
1 + 2	0	10	10
Menu Home			

Fig. Device display of the sum (L1..L3) of active, reactive and apparent energy according to tariffs

i INFORMATION

Configure tariff switching using the GridVis® software!

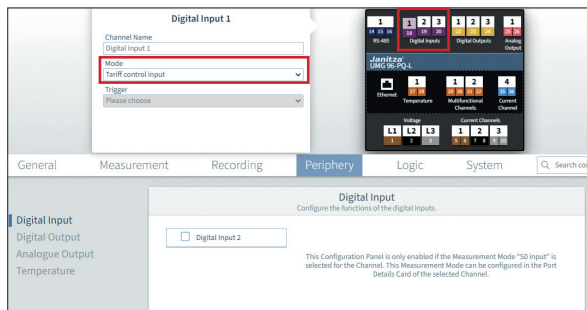

Fig. Configuration of digital input 1 as a tariff control input in the GridVis® software

13.21 Time synchronization

Synchronous data acquisition from several measurement devices requires that the device time in all measurement devices be synchronized regularly.

There are 4 options for time synchronization:

1. Via the **RS-485 interface** by means of a **UTC time stamp** in a Modbus address.
2. Via the **RS-485 interface** according to **DIN EN 60870** in several Modbus addresses.
3. Via the NTP protocol of a time server at the **Ethernet interface**. The device must be equipped with the 96-PA-RCM-EL module to do this.
4. Via time pulses on **digital input 2** of the device.

The type of time synchronization must be configured in the GridVis® software.

13.21.1 RS-485 interface (UTC time pulse)

With this type of synchronization, the GridVis® software sends a UTC time stamp via the RS-485 interface (Modbus). The measurement device applies the time from the Modbus address 100.

13.21.2 RS-485 interface (DIN EN 60870)

The GridVis® software sends a time stamp for synchronization via Modbus. The Modbus addresses are based on the time structure of DIN EN 60870:

Modbus address	Function
31500	Synchronization in milliseconds
31501	Synchronization in minutes and hours
31502	Synchronization in date, weekdays, months
31503	Synchronization in years

The device can monitor whether or not a time stamp for synchronization has been received. The monitoring time (*Validation interval*) is configurable (1 to 168 h, 0 = alarm switched off).

INFORMATION

If the validation interval has expired without the device having received a new time, the display shows the warning "Clock unsynchronized".

This warning is automatically removed as soon as the device has received a new time synchronization via the specified Modbus addresses.

Broadcast via Modbus

As an alternative to normal synchronization, any Modbus device can transmit the time as a broadcast data packet to other devices:

- One device is the time source (master) and sends the time in Modbus addresses as a broadcast.
- The devices connected via Ethernet or RS-485 receive the time without sending a synchronization signal in response.

13.21.3 Ethernet interface - measurement devices with an Ethernet module

To do so, the measurement device must be permanently connected to an NTP server on the Internet or in the local network via the module's Ethernet interface.

- In the device configuration of the GridVis® software, activate the time synchronization via NTP (external time server).
- Then configure the time synchronization via an NTP time server, e.g. from PTB (Physikalisch-Technische Bundesanstalt):
 - ptbtime1.ptb.de
 - ptbtime2.ptb.de
 - ptbtime3.ptb.de

13.21.4 Digital input 2

For this type of synchronization, connect a time pulse generator to digital input 2, e.g. the electric utility pulse or a GPS time source (GPS radio receiver for receiving and processing a GPS time signal, available as a Janitza accessory).

13.22 "Low battery" and "Set time" warnings

i INFORMATION

The measurement device

- Sets the time to the factory setting when the supply voltage is disconnected and the battery is simultaneously spent or after the battery is changed, meaning it is therefore considered "not set"!
- Saves correct data records only when the time is set!

To ensure that a battery change takes place without loss of data, the device warns of an imminent battery change with the warning message "**Battery voltage low**":

Battery level low 10:05				
	Voltage	Current	Power	PF1
L1	223V	0.03A	0.00kW	~ 1.00
L2	223V	0.03A	0.00kW	~ 1.00
L3	223V	0.03A	0.00kW	~ 1.00
L1..L3	50.06Hz	0.09A	0.00kW	~ 1.00
Active energy			Reactive energy ind.	
L1..L3	0.0kWh		0.0kvarh	
Menu	Alarms			

Fig. Warning "Battery voltage low"

- **Change the battery as described in section „15.6 Clock/Battery“ on page 109!**
- After the battery change, the device display shows the warning message "**Please set the time**".
- Configure the time (date, time) as described in Sect. 12.6 on page 53.

Please set the time 10:00				
	Voltage	Current	Power	PF1
L1	223V	0.03A	0.00kW	~ 1.00
L2	223V	0.03A	0.00kW	~ 1.00
L3	223V	0.03A	0.00kW	~ 1.00
L1..L3	50.06Hz	0.09A	0.00kW	~ 1.00
Active energy			Reactive energy ind.	
L1..L3	0.0kWh		0.0kvarh	
Menu	Alarms			

Fig. Warning "Please set the time"

14. Overview of menus and displays

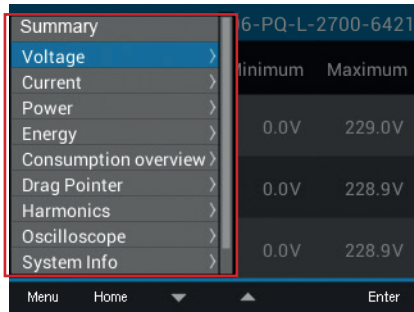

Opening a menu

- Press button 1 (*Menu*) to open the menu.
- Use buttons 3 (▼) and 4 (▲) to select the desired menu and confirm with button 6 (*Enter*).

The most important displays are shown below (depending on the equipment).

14.1 Overview menu (start screen)



Start screen (depending on the connection variant)

Summary		UMG 96-PQ-L			
	Voltage	Current	Power	PF1	
L1	223V	0.03A	0.00kW	≈ 1.00	
L2	223V	0.03A	0.00kW	≈ 1.00	
L3	223V	0.03A	0.00kW	≈ 1.00	
L1..L3	50.06Hz	0.09A	0.00kW	≈ 1.00	
Active energy		Reactive energy ind.			
L1..L3	0.0kWh		0.0kvarh		

Three-phase 4-conductor system: Display of

- Voltage L1-N, L2-N, L3-N, frequency;
- Current L1, L2, L3 and sum of L1..L3;
- Power L1, L2, L3 and sum of L1..L3;
- Power factor and sum of L1..L3;
- Sum of active and reactive energy L1-L3

Summary		UMG 96-PQ-L			
	Voltage	Current	Power	PF1	
L1-L2	0V	0.000A	---	---	
L2-L3	0V	0.000A	---	---	
L3-L1	0V	0.000A	---	---	
L1..L3	50.00Hz	0.000A	0.00kW	≈ 1.00	
Active energy		Reactive energy cap.			
L1..L3	-0.0kWh		0.0kvarh		

Three-phase 3-conductor system: Display of

- Voltage L1-L2, L2-L3, L3-L1, frequency;
- Current L1, L2, L3 and vectorial sum of L1..L3;
- Sum values: Power, power factor; active and reactive energy L1-L3

Summary		UMG 96-PQ-L			
	I	I max.	U	3 x P	
L3	0.000A	0.000A	0V	0.00kW	
L3	0.000A	0.000A	0V	-0.00kW	
L3	0.000A	0.000A	0V	0.00kW	
---		---		---	
Frequency					
L3	50.00Hz				

Symmetrically loaded networks 3 x L3 (3p1w, only for UMG 96-PA, not UMG 96-PA-MID+): Display of

- Current, maximum current and voltage per network
- Power per network (multiplied by factor 3)
- Frequency

i INFORMATION

With the 3p1w connection variant (3 x L3), the start screen shows correct measured values.

Other display indicators are not designed for this connection variant and may show invalid measured values. This mainly affects the following menus or displays:

- Voltage >Phasor diagram
- Power (active, reactive and apparent power)
- Energy (active, reactive and apparent energy, tariff)
- Consumption overview
- Drag indicator

14.2 Voltage menu

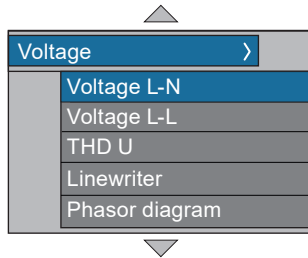

Voltage L-N

Voltage		UMG 96-PQ-L		
	Value	Minimum	Maximum	
L1-N	223.2V	1.7V	223.5V	
L2-N	223.1V	1.7V	223.4V	
L3-N	223.2V	1.7V	223.5V	
Menu		Home		Min/Max

Display of voltage L1-N, L2-N, L3-N and their min. / max. values

Voltage L-L

Voltage		UMG 96-PQ-L		
	Value	Minimum	Maximum	
L1-L2	1.3V	0.1V	223.8V	
L2-L3	2.0V	0.1V	223.7V	
L1-L3	0.0V	0.0V	0.0V	
Menu		Home		Min/Max

Display of voltage L1-L2, L2-L3, L1-L3 and their min. / max. values

THD U

THD U		UMG96-PQ-L-2700-6421		
	Value	Minimum	Maximum	
L1-N	69.06 %	45.90 %	121.1 %	
L2-N	143.0 %	81.49 %	164.2 %	
L3-N	229.8 %	122.0 %	1127 %	
Menu		Home		Delete

Total distortion factors of the voltages relative to the fundamental oscillation

History

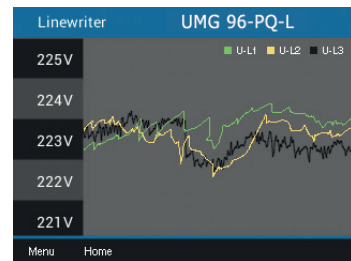

Display of voltage history of L1-N, L2-N, L3-N

Phasor diagram (star) (Three-phase 4-conductor system)

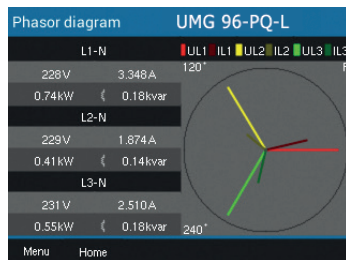

Phase shifts between voltages (long) and currents (short).
For colors, see Configuration > Display.

Phasor diagram (triangle) (Three-phase 3-conductor system)

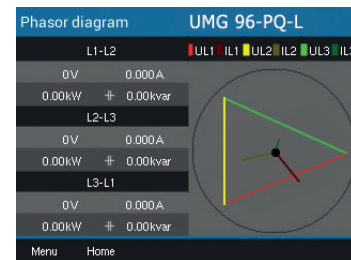

Phase shifts between voltages (long) and currents (short).
For colors, see Configuration > Display.

14.3 Current menu

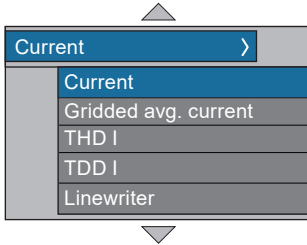

Current

Current		UMG 96-PQ-L	
	Value	Max. avg.	Max.
L1	0.03 A	0.0 A	0.0 A
L2	0.03 A	0.0 A	0.0 A
L3	0.02 A	0.0 A	0.0 A

Menu Home Min/Max

Currents L1-N, L2-N, L3-N and their min. / max. values

Gridded average values

Gridded avg.		UMG96-PQ-L-2700-6421	
	Gridded avg.		
L1	0.000 A		
L2	0.000 A		
L3	0.000 A		

Menu Home

Gridded average values of the currents

THD-I

THD I		UMG 96-PQ-L	
	Value	Minimum	Maximum
L1	16.19 %	15.84 %	16.43 %
L2	16.19 %	15.78 %	16.46 %
L3	16.23 %	15.82 %	16.41 %

Menu Home Min/Max

Total distortion factors of the currents relative to the fundamental oscillation

TDD I

TDD I		UMG96-PQ-L-2700-6421	
	Value	Average	Maximum
L1	0.000 %	0.000 %	0.000 %
L2	0.000 %	0.000 %	0.000 %
L3	0.000 %	0.000 %	0.000 %

Menu Home Delete

Distortion relative to the configured nominal current (Total Demand Distortion)

History

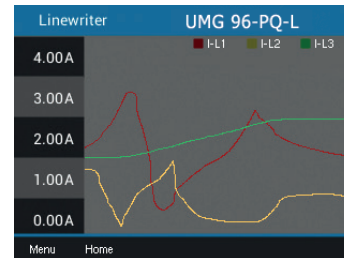

Current histories L1-N, L2-N, L3-N

14.4 Power menu

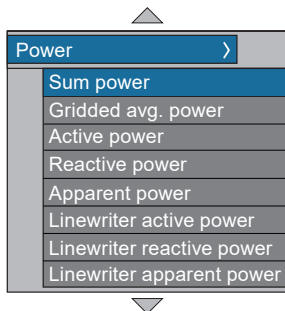

Total power

Power UMG 96-PQ-L			
	Value	Minimum	Maximum
P	-0.1W	-0.1W	0.1W
Q	19.6VAr	0.0VAr	19.7VAr
S	19.9VA	0.1VA	23.1VA

Sum (L1..L3) of active, reactive, apparent power and their min./max. values

Gridded average values

Gridded avg. UMG96-PQ-L-2700-6421			
	P	Q	S
L1	0.00kW	0.00kvar	0.00kVA
L2	0.00kW	0.00kvar	0.00kVA
L3	0.00kW	0.00kvar	0.00kVA
L1..L3	0.00kW	0.00kvar	0.00kVA

Gridded average values of active, reactive, and apparent power

Active, reactive, apparent power

Active power UMG 96-PQ-L			
	Value	Minimum	Maximum
L1	-0.0W	-0.0W	0.5W
L2	-0.0W	-0.5W	0.0W
L3	-0.0W	-0.0W	0.0W

Power values L1-N, L2-N, L3-N and their min./max. values (only available in three-phase 4-conductor systems)

History of active, reactive, apparent power

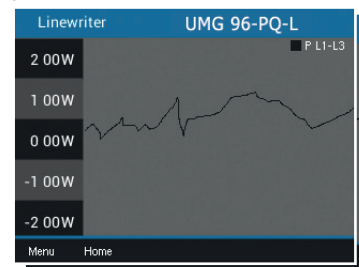

History of active, reactive or apparent power (sum L1..L3)

14.5 Energy menu

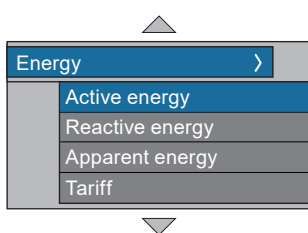

Active, reactive, apparent energy

Active energy UMG 96-PQ-L	
Sum L1..L3	
Total	0.0kWh
Consumed	0.0kWh
Delivered	0.0kWh

Sum (L1..L3) of active, reactive and apparent energy

Tariff

Tariff UMG 96-PQ-L			
Tariff	Active E. [kWh]	Reactive E. [kVAh]	Apparent E. [kVAh]
1	0	0	0
2	0	10	10
1 + 2	0	10	10

Sum (L1..L3) of active, reactive and apparent energy according to tariffs

14.6 Consumption overview menu

Consumption overview >

Daily >

Active energy

Reactive energy

Apparent energy

Monthly >

Active energy

Reactive energy

Apparent energy

Daily

Display of active, reactive or apparent energy per day of the current month

Monthly

Display of active, reactive or apparent energy per month of the last three years

14.7 Drag indicator menu

Drag Pointer >

Current >

L1

L2

L3

Active power >

L1

L2

L3

L1..L3

Apparent power >

L1

L2

L3

L1..L3

Current L1, L2, L3

Current L1			UMG 96-PQ-L
Drag Pointer	Value	Date & Time	
1.	5.033A	27.07.20 11:38	
2.	4.158A	27.07.20 11:40	
3.	3.825A	27.07.20 11:37	

Drag indicator: The 3 highest, last-measured values, averaged over the set period duration.

Active power L1, L2, L3

Active power L1			UMG 96-PQ-L
Drag Pointer	Value	Date & Time	
1. Con.	1395W	14.07.20 10:50	
2. Con.	1188W	01.08.20 09:58	
3. Con.	0.000W	-----	
1. Del.	395W	14.07.20 10:50	
2. Del.	270W	01.08.20 09:58	
3. Del.	0.000W	-----	

Drag indicator display of the active powers (Con. = consumed, Del. = delivered)

Active power, sum L1..L3

Active power Σ			UMG 96-PQ-L
Drag Pointer	Value	Date & Time	
1. Con.	3487W	27.07.20 11:38	
2. Con.	2886W	27.07.20 11:40	
3. Con.	2201W	27.07.20 11:37	
1. Del.	1395W	27.07.20 11:43	
2. Del.	1395W	27.07.20 11:44	
3. Del.	1188W	27.07.20 11:42	

Drag indicator display of the active power sum L1..L3 (Con. and Del.)

Apparent power L1, L2, L3

Apparent pwr L1			UMG 96-PQ-L
Drag Pointer	Value	Date & Time	
1.	739VA	27.07.20 11:38	
2.	818VA	27.07.20 11:40	
3.	737VA	27.07.20 11:37	

Drag indicator display of the apparent power

Apparent power, sum L1..L3

Apparent pwr Σ			UMG 96-PQ-L
Drag Pointer	Value	Date & Time	
1.	3487VA	27.07.20 11:38	
2.	2886VA	27.07.20 11:40	
3.	2201VA	27.07.20 11:37	

Drag indicator display of the apparent power sum L1..L3

99

14.8 Harmonics menu

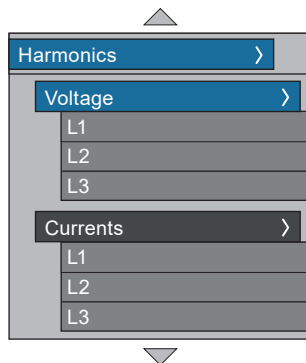

Voltage L1, L2, L3

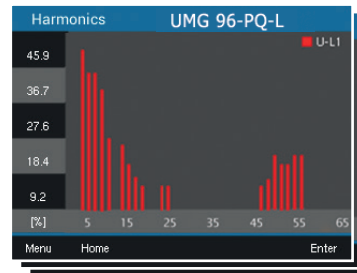

Display of harmonics up to the 65th harmonic. (Voltage L1, L2, L3)

Current L1, L2, L3

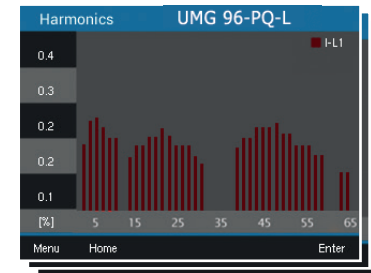

Display of harmonics up to the 65th harmonic. (Current L1, L2, L3)

i INFORMATION

Further menu items are available with module 96-PA-RCM-EL.

14.9 Oscilloscope menu

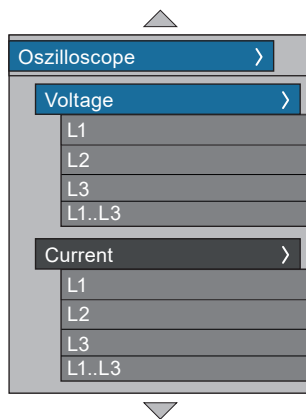

Voltage L1 / L2 / L3

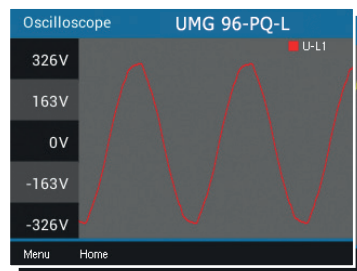

Display oscillogram of voltage L1, L2 or L3

Voltage L1..L3

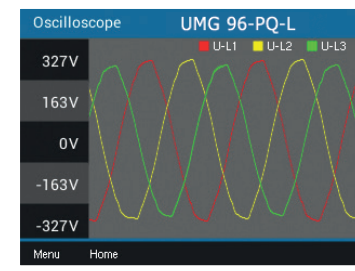

Display oscillogram of voltages L1, L2 and L3

Current L1 / L2 / L3

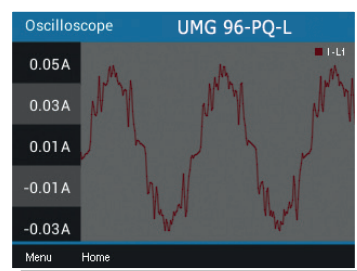

Display oscillogram of the currents L1, L2 or L3

Current L1 / L2 / L3

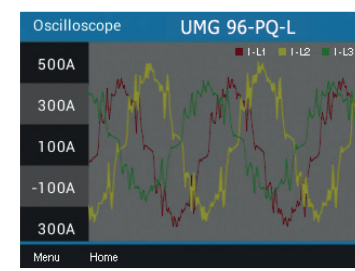

Display oscillogram of the currents L1, L2 or L3

14.10 Events menu

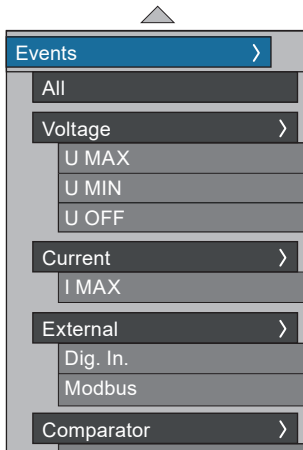

All events

Phase	Events	Date & Time
L1..L3	UMIN	11.10.21 17:25:18,508
L3	UMIN	11.10.21 17:25:18,589
L2	UMIN	11.10.21 17:25:18,589
L1	UMIN	11.10.21 17:25:18,589
L1..L3	UMAX	11.10.21 17:25:18,508
L3	UMAX	11.10.21 17:25:18,589

List of all events in the three-phase 4-wire system

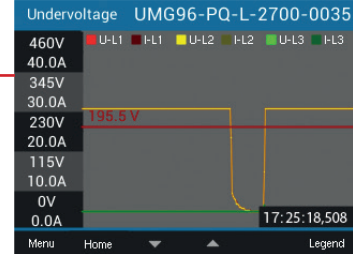

Sequence of undervoltage in three-phase 4-wire system

All events

Phase	Events	Date & Time
---	MODBUS	02.11.21 14:20:24,000
L1..L3	UMAX	02.11.21 14:13:07,960
L3-L1	UMAX	02.11.21 14:13:07,960
L2-L3	UMAX	02.11.21 14:13:07,960
L1-L2	UMAX	02.11.21 14:13:07,960

List of all events in the three-phase 3-wire system

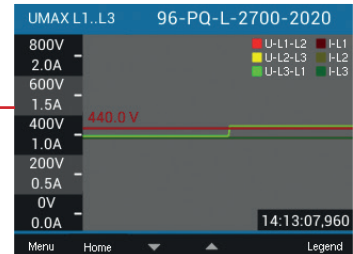

Sequence of an overvoltage in the three-phase 3-wire system

i INFORMATION

Further menu items are available with module 96-PA-RCM-EL. The manner of display for events and sequences differs depending on the configured **Connection variant** (see section "12.4.4 Connection variant" on p. 48).

Overvoltage U MAX

Phase	Value	Date & Time
L3	259.7 V	28.10.21 11:03:14,939
L2	259.6 V	28.10.21 11:03:14,939
L1	260.0 V	28.10.21 11:03:14,939
L1..L3	260.0 V	28.10.21 10:59:14,940
L3	259.9 V	28.10.21 10:59:14,940
L2	259.9 V	28.10.21 10:59:14,940

List of overvoltage events

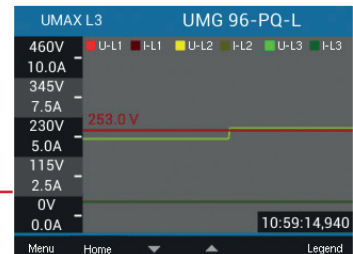

Sequence of an overvoltage event

Undervoltage U MIN

Phase	Value	Date & Time
L1..L3	165.0 V	11.10.21 17:25:18,589
L3	68.7 V	11.10.21 17:25:18,589
L2	68.1 V	11.10.21 17:25:18,589
L1	68.1 V	11.10.21 17:25:18,589
L1..L3	110.6 V	11.10.21 17:25:13,527
L3	68.9 V	11.10.21 17:25:13,527

List of undervoltage events

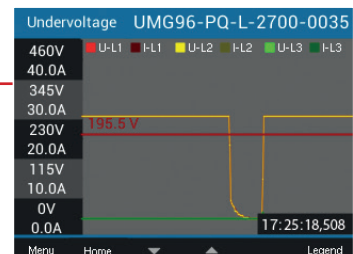

Sequence of an undervoltage event

Voltage interruption U OFF

Phase	Value	Date & Time
L1..L3	9.8 V	11.10.21 17:25:10,520
L3	6.9 V	11.10.21 17:25:10,520
L2	7.1 V	11.10.21 17:25:10,500
L1	7.1 V	11.10.21 17:25:10,500
L1..L3	10.6 V	11.10.21 17:08:40,200
L3	3.8 V	11.10.21 17:08:40,200

List of voltage interruptions

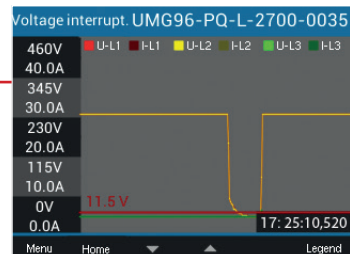

Sequence of a voltage interruption

Overcurrent I MAX

Phase	Value	Date & Time
L1..L3	6.00 A	28.10.21 11:12:10,340
L3	5.92 A	28.10.21 11:12:10,340
L1	5.84 A	28.10.21 11:12:10,340
L2	6.00 A	28.10.21 11:12:10,340
L1..L3	6.00 A	28.10.21 11:10:10,340
L3	6.00 A	28.10.21 11:10:10,340

List of all overcurrent events

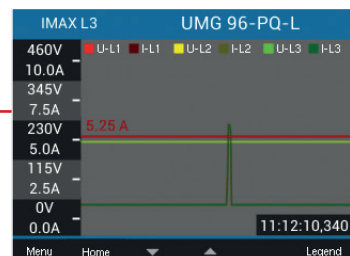

Sequence of an overcurrent event

External > Digital input

Phase	Value	Date & Time
---	Dig. In. 0	11.10.21 17:20:10,039
---	Dig. In. 0	11.10.21 17:20:10,039
---	Dig. In. 0	11.10.21 17:19:29,039
---	Dig. In. 0	11.10.21 17:19:29,039
---	Dig. In. 0	11.10.21 17:18:43,039
---	Dig. In. 0	11.10.21 17:18:43,039

List of external events via digital inputs

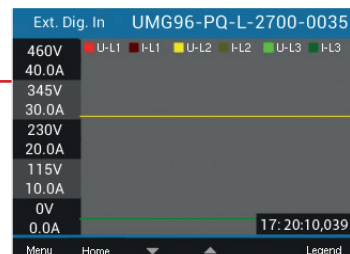

Sequence of an event at a digital input

External > Modbus

Phase	Value	Date & Time
---	---	11.10.21 17:15:11,411
---	---	11.10.21 17:15:09,489
---	---	11.10.21 17:15:07,476
---	---	11.10.21 17:14:49,000

List of external Modbus events

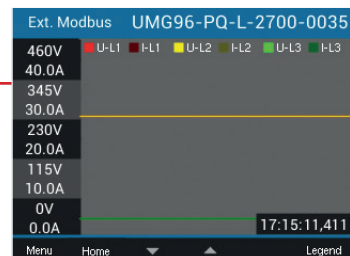

Sequence of a Modbus event

14.11 System Info menu

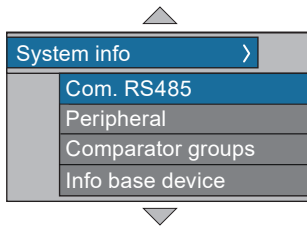

i INFORMATION

Further menu items are available with module 96-PA-RCM-EL.

RS-485 communication

Com. RS485		UMG 96-PQ-L	
	RX	TX	Error
RS485	0	0	0
RS485 Mode	Modbus		
Device address	1		
Baud rate	115200		
Timeout	350 ms		
Menu Home			

Received (RX), sent (TX) and faulty data packets, RS-485 mode, device address, baud rate and timeout

Peripherals

Peripheral		UMG 96-PQ-L		
I/O	No. 1	No. 2	No. 3	
Digital in	LOW	LOW	LOW	
Digital out	LOW	HIGH	LOW	
Analog out	0.0mA			
Menu Home				

States of the digital inputs and outputs, value of the analog output

Comparator groups

Selection of a comparator group

Comparator group 1

Display of limit value, actual value, comparator running time, logic and status

Basic device info

Info base device		UMG 96-PQ-L
Type	UMG 96-PA	
Serial no.	43001234	
Version	3.00 / 4.00	
Software ID	54e134f86a75c9e7 ea8d536f5s8cdf83	
Uptime	0d 00h 02m 47s	
Malo ID	---	
Menu Home		

Device type, serial number, firmware version, software ID, running time (since last power-on or software reset) and market location ID

14.12 Configuration menu – Password entry

The configuration of the measurement device can be protected with a password (the default setting is 00000, i.e. no password).

If a password is set, you must enter it to view or change the device configuration.

Summary	>
Voltage	>
Current	>
Power	>
Energy	>
Consumption overview	>
Drag Pointer	>
Harmonics	>
Oszilloscope	>
Events	>
System info	>
Configuration	>

Querying the current password

Configuration	
Password	00000
Version	3.10
Software ID	7b967fed0351809e
	096364c82ada249c
Esc Enter	

Configuration	
Password	00000
Version	3.40
Software ID	7b967fed0351809e
	096364c82ada249c
Esc Enter	

Enter the password using buttons 3 (▼) and 4 (▲).
Switch between the digits using buttons 2 (◀) and 5 (▶).

Configuration	
Language	English
Communication	->
Measurement	->
Display	->
System	->
Modbus Editor	->
Esc ▼ ▲ Enter	

After entering the password, you can access the configuration (see the following pages).

14.13 Configuration menu – without password/after password entry

Summary	>
Voltage	>
Current	>
Power	>
Energy	>
Consumption overview	>
Drag Pointer	>
Harmonics	>
Oszilloscope	>
Events	>
System info	>
Configuration	>

For information on the entries in the Configuration menu, see section "12. Configuration" on p. 44.

Language

Configuration	
Language	English
Communication	->
Measurement	->
Display	->
System	->
Modbus Editor	->

Configuration	
Language	English
Communication	->
Measurement	->
Display	->
System	->
Modbus Editor	->

Setting the language, German/English

Communication

Configuration	
Language	English
Communication	->
Measurement	->
Display	->
System	->
Modbus Editor	->

Communication	
Field bus	
Device address	1
Baud rate	115200
Framing	1 stopbit

Fieldbus settings device address, baud rate and data frame

Measurement

Configuration	
Language	English
Communication	->
Measurement	->
Display	->
System	->
Modbus Editor	->

Measurement	
Transformer	->
Connection type	4w3m
Nominal current	150A
Nominal frequency	Auto (45-65 Hz)

Settings of the transformers, the connection variant, the nominal current and the nominal frequency

	primary	secondary
Current transformer	5A	5A
Voltage transformer	400V	400V

Settings of current and voltage transformers (primary and secondary)

Display

Configuration	
Language	English
Communication	->
Measurement	->
Display	->
System	->
Modbus Editor	->

Display	
Brightness	100%
Standby delay	900s
Brightness (standby)	30%
Colors	->

Settings for brightness, standby time after and brightness (standby)

Display	
Brightness	70%
Standby delay	900s
Brightness (standby)	30%
Auto Home return	Yes
Home delay	90s
Colors	->

Settings for automatic return to the start screen

Display	
Brightness	70%
Standby delay	900s
Brightness (standby)	30%
Auto Home return	Yes
Home delay	90s
Colors	->

Colors		
	Voltage	Current
L1		
L2		
L3		

Settings for the display colors of voltage and current (L1, L2, L3)

System

Configuration	
Language	English
Communication	->
Measurement	->
Display	->
System	->
Modbus Editor	->

System	
Version	3.10 / 3.10
Serial no.	43000009
Time	30.10.18 17:48:02
Password	00000
Reset	->

Firmware version and serial number. Setting the time and password

Reset	
Energy	No
Min./Max. values	No
Factory settings	No
Restart	No

Resetting of energy measured values, min. and max. values. Reset to standard factory settings or restart of the measurement device

Modbus editor

Configuration	
Language	English
Communication	->
Measurement	->
Display	->
System	->
Modbus Editor	->
Esc	Enter

Communication	
Modbus Editor	
Address	30001
Value	0
Minimum	0
Maximum	65535
Type	short
Access	read/write
Esc	Enter

Display Modbus register (address, value) and set values

15. Service and maintenance

Prior to outbound delivery, the device is subjected to various safety tests and is marked with a seal. If a device is opened, the safety tests must be repeated. A warranty is only assumed for unopened devices.

15.1 Repair and calibration

Repair and calibration of the device must only be carried out by the manufacturer or an accredited laboratory! The manufacturer recommends calibrating the device every 5 years!



WARNING

Warning of unauthorized tampering or improper use of the device.

Opening, dismantling or unauthorized manipulation of the device which goes beyond the mechanical, electrical or other operating limits indicated can lead to material damage or injury, up to and including death.

- Only electrically qualified personnel are permitted to work on the devices and their components, assemblies, systems and current circuits!
- Always use your device or component only in the manner described in the associated documentation.
- In the event of visible damage, or for the purpose of repair and calibration, return the device to the manufacturer!

15.2 Front panel foil and display

Please note the following for the care and cleaning of the front foil and the display:

INFORMATION

Material damage due to improper care and cleaning of the device.

The use of water or other solvents, such as denatured alcohol, acids, acidic agents for the front foil or the display can damage or destroy the device during cleaning. Water can, for example, penetrate into the device housing and destroy the device.

- Clean the device, the front foil or the display with a soft cloth.
- Use a cloth moistened with clear water for heavy soiling.
- Clean the front panel foil and the display, e.g. fingerprints, with a special LCD cleaner and a lint-free cloth.
- Do not use acids or acidic agents to clean the devices.

15.3 Service

For questions not answered or described in this manual, please contact the manufacturer. Please be certain to have the following information ready to answer any questions:

- Device designation (see rating plate)
- Serial number (see rating plate)
- Software release (see system display)
- Measured voltage and supply voltage
- An exact error description.

15.4 Device adjustment

The manufacturer adjusts the devices before delivery. No readjustment is required when the environmental conditions are complied with.

15.5 Firmware update

For a firmware update, connect your device to a computer and obtain access via the **GridVis**[®] software:

- Open the Firmware Update Wizard by clicking on "Update Device" in the "Extras" menu.
- Select your update file and perform the update.

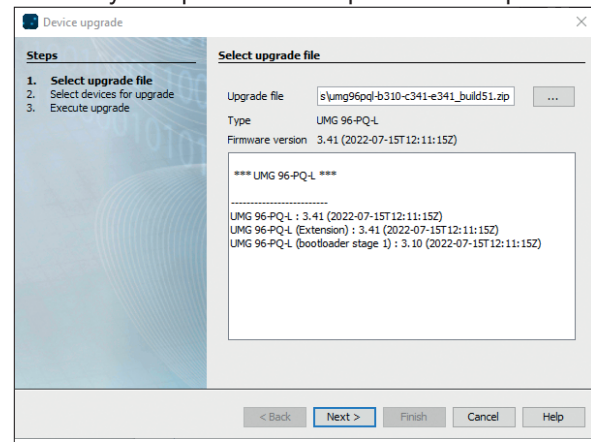

Fig. Updating the device firmware in the GridVis[®] software

15.6 Clock/Battery

The supply voltage supplies the internal clock of the measurement device. If the supply voltage fails, the battery takes over the supply of voltage to the clock. The clock provides date and time information, for example for recordings and min. and max. values.

INFORMATION

The device:

- Saves correct data records only when the time is set!
- Sets the time to the factory setting when the supply voltage is disconnected and the battery is simultaneously spent or after the battery is changed, meaning it is therefore considered “not set”.

The life expectancy of the battery is at least 5 years at a storage temperature of +45° C. The typical battery life is 8 to 10 years.

The battery can be replaced via the battery insert on the bottom of the device. **When replacing the battery, make sure that the battery type and polarity are correct** (positive pole points to the rear of the device; negative pole points to the front of the device)!

Pay attention to the following when replacing the battery:



WARNING

Risk of injury due to electrical voltage!

Severe bodily injury or death can result from:

- Touching bare or stripped leads that are energized.
- Device inputs that pose a hazard when touched.

Observe the following when handling your device and when replacing the battery; before starting work:

- Disconnect the system/device from the power supply!
- Secure it against being switched on!
- Check to be sure it is de-energized!
- Ground and short circuit!
- Cover or block off adjacent live parts!

INFORMATION

Grease or dirt on the contact surfaces forms a contact resistance which shortens the service life of the battery. Only touch the battery by the edges.

16. Procedure in the event of a malfunction

Failure mode	Cause	Remedy
No display	External fuse for the supply voltage has tripped.	Replace fuse.
No current display.	No measured voltage connected.	Connect measured voltage.
	No measured current connected.	Connect measured current.
Displayed current is too great or too small.	Current measurement on the wrong phase.	Check connection and correct if necessary.
	Current transformer factor incorrectly programmed.	Read and program the current transformer ratio on the current transformer.
	The peak current value at the measurement input was exceeded by current harmonics.	Install current transformers with a higher current transformer ratio.
	The current at the measurement input is too low.	Install current transformers with a lower current transformer ratio.
Displayed voltage is too low or too high.	Measurement on the wrong phase.	Check connection and correct if necessary.
	Voltage transformer programmed incorrectly.	Read the voltage transformer ratio on the voltage transformer and program.
Displayed voltage is too low.	Overrange.	Use a voltage transformer.
	The voltage peak value at the measurement input was exceeded due to harmonics current.	Attention! Make sure that the measurement inputs are not overloaded.
Phase shift, ind./cap.	Current circuit is assigned to the wrong voltage circuit.	Check connection and correct if necessary.
Active power consumption / delivered is interchanged.	At least one current transformer connection is reversed.	Check connection and correct if necessary.
	A current circuit is assigned to the wrong voltage circuit.	Check connection and correct if necessary.
Active power too small or too great.	The programmed current transformer ratio is incorrect.	Read and program the current transformer ratio on the current transformer
	The current circuit is assigned to the wrong voltage circuit.	Check connection and correct if necessary.
	The programmed voltage transformer ratio is incorrect.	Read the voltage transformer ratio on the voltage transformer and program.
An input or output is not responding.	The input/output was programmed incorrectly.	Check programming and correct if necessary.
	The input/output was connected incorrectly.	Check connection and correct if necessary.
Display "Overrange"	The measuring range has been exceeded	Check connection and correct if necessary. Correct current/voltage transformer ratio.
No connection to the device.	RS-485 - Incorrect device address. - Different bus speeds (baud rate) and / or data frames - Incorrect protocol. - No termination.	- Correct the device address. - Correct the speed (baud rate). - Correct the data frame. - Correct the protocol. - Terminate bus with termination resistor.
Despite the above measures, the device does not function.	Device defective.	Send the device and error description to the manufacturer for inspection.

17. Technical data

General	
Net weight (with attached plug-in connectors)	approx. 250 g (0.55 lbs)
Package weight (incl. accessories)	approx. 500 g (1.1 lbs)
Battery	Type Lithium CR2032, 3 V, (UL 1642 approved)
Data memory	64 MB
Backlight service life	40000 h (backlight reduces to approx. 50% over this period)
Impact resistance	IK07 according to IEC 62262

Transport and storage	
The following information applies to devices that are transported or stored in their original packaging.	
Free fall	1 m (39.37 in)
Temperature	-25 °C (-13 °F) to +70 °C (158 °F)
Relative air humidity (non-condensing)	0 to 90% RH

Environmental conditions during operation	
Install the device in a weather-protected and stationary location. Protection class II according to IEC 60536 (VDE 0106, Part 1).	
Rated temperature range	-10 °C (14 °F) ... +55 °C (131 °F)
Relative air humidity (non-condensing)	0 to 75% RH
Operating elevation	0 .. 2000 m (6562 ft) above sea level
Pollution degree	2
Mounting orientation	As desired
Ventilation	No forced ventilation required.
Protection against foreign matter and water	
- Front	IP40 according to EN60529
- Rear	IP20 according to EN60529
- Front with seal	IP54 according to EN60529

Supply voltage		
Option 230 V	Nominal range	AC 90 V - 277 V (50/60 Hz) or DC 90 V - 250 V, 300 V CAT III
	Power consumption	max. 4.5 VA / 2 W
Option 24 V	Nominal range	AC 24 V - 90 V (50/60Hz) or DC 24 V - 90 V, 150 V CAT III
	Power consumption	max. 4.5 VA / 2 W
Operating range	+-10% of nominal range	
Internal fuse, not replaceable	Type T1A / 250 V DC / 277 V AC according to IEC 60127	
Recommended overcurrent protective device for the line protection (UL approval)	Option 230 V: 6 - 16 A (Char. B) Option 24 V: 1 - 6 A (Char. B)	

Voltage measurement	
Three-phase 4-conductor systems with rated voltages up to	417 V / 720 V (+-10%) according to IEC 347 V / 600 V (+-10%) according to UL
Three-phase 3-conductor systems with rated voltages up to	600 V (+10%)
Single-phase 2-conductor system with rated voltages up to	480 V (+-10%)
Overvoltage category	600 V CAT III, 300 V CAT IV
Rated surge voltage	6 kV
Protection of the voltage measurement	1 - 10 A tripping characteristic B(with IEC/UL approval)
Measuring range L-N	0 ¹⁾ .. 600 V _{rms} (max. overvoltage 800 V _{rms})
Measuring range L-L	0 ¹⁾ .. 1040 V _{rms} (max. overvoltage 1350 V _{rms})
Resolution	0.01 V
Crest factor	2.45 (related to the measuring range)
Impedance	3 MΩ/phase
Power consumption	approx. 0.1 VA
Sampling frequency	13.67 kHz
Frequency of the fundamental oscillation - Resolution	45 Hz .. 65 Hz 0.01 Hz
Fourier analysis	1st - 65th Harmonics

1) The device only determines measured values if a voltage L1-N of greater than 20 V_{eff} (4-conductor measurement) or a voltage L1-L2 of greater than 34 V_{eff} (3-conductor measurement) is applied to voltage measurement input V1.

Current measurement	
Measuring range: Low-power current transformers or active Rogowski coils (setting: <i>Low Power</i>)	0.3 .. 400 mV RMS
Measuring range: passive Rogowski coils (setting: <i>Rogowski</i>)	1 .. 800 mV RMS
Crest factor	2
Overload for 1 second	3 V
Resolution	0.0001 V
Sampling frequency	13.67 kHz
Fourier analysis	1st - 65th Harmonics (I1 .. I3) 1st - 40th Harmonics (I4)

Serial interface	
RS-485 - Modbus RTU/client device	9.6 kbps, 19.2 kbps, 38.4 kbps, 57.6 kbps, 115.2 kbps

Digital outputs	
3 digital outputs, solid state relays, not short-circuit proof.	
Switching voltage	max. 33 V AC, 40 V DC
Switching current	max. 50 mA _{eff} AC/DC
Response time	approx. 200 ms
Pulse output	max. 50 Hz (energy pulses)

Digital inputs	
3 digital inputs, solid state relays, not short-circuit proof.	
Maximum counter frequency	20 Hz
Input signal applied	18 V .. 28 V DC (typically 4 mA)
Input signal not applied	0 .. 5 V DC, current less than 0.5 mA

Cable length (digital inputs/outputs)	
Up to 30 m (32.81 yd)	Unshielded
Greater than 30 m (32.81 yd)	Shielded

Analog outputs	
External power supply	max. 33 V
Current	0 .. 20 mA
Update time	1 s
Load	max. 300 Ω
Resolution	10 bit

Connection capacity of the terminals (supply voltage)	
Connectible conductors. Only connect one conductor per terminal point!	
Single core, multi-core, fine-stranded	0.2 - 4.0 mm ² , AWG 28-12
Wire ferrules (non-insulated)	0.2 - 2.5 mm ² , AWG 26-14
Wire ferrules (insulated)	0.2 - 2.5 mm ² , AWG 26-14
Tightening torque	0.4 - 0.5 Nm (3.54 - 4.43 lbf in)
Strip length	7 mm (0.2756 in)

Connection capacity of the terminals (voltage measurement)	
Connectible conductors. Only connect one conductor per terminal point!	
Single core, multi-core, fine-stranded	0.2 - 4.0 mm ² , AWG 28-12
Wire ferrules (non-insulated)	0.2 - 2.5 mm ² , AWG 26-14
Wire ferrules (insulated)	0.2 - 2.5 mm ² , AWG 26-14
Tightening torque	0.4 - 0.5 Nm (3.54 - 4.43 lbf in)
Strip length	7 mm (0.2756 in)

Connection capacity of the terminals (low power current measurement)	
Connectible conductors. Only connect one conductor per terminal point!	
Single core, multi-core, fine-stranded	0.2 - 1.5 mm ² , AWG 28-16
Wire ferrules (non-insulated)	0.2 - 1.5 mm ² , AWG 26-16
Wire ferrules (insulated)	0.2 - 1.5 mm ² , AWG 26-16
Tightening torque	0.2 - 0.25 Nm (1.77 - 2.21 lbf in)
Strip length	7 mm (0.2756 in)

Connection capacity of the terminals (serial interface)	
Connectible conductors. Only connect one conductor per terminal point!	
Single core, multi-core, fine-stranded	0.2 - 1.5 mm ² , AWG 28-16
Wire ferrules (non-insulated)	0.2 - 1.5 mm ² , AWG 26-16
Wire ferrules (insulated)	0.2 - 1.5 mm ² , AWG 26-16
Tightening torque	0.2 - 0.25 Nm (1.77 - 2.21 lbf in)
Strip length	7 mm (0.2756 in)

Connection capacity of the terminals (digital inputs/outputs, analog output)	
Connectible conductors. Only connect one conductor per terminal point!	
Single core, multi-core, fine-stranded	0.2 - 1.5 mm ² , AWG 28-16
Wire ferrules (non-insulated)	0.2 - 1.5 mm ² , AWG 26-16
Wire ferrules (insulated)	0.2 - 1.5 mm ² , AWG 26-16
Tightening torque	0.2 - 0.25 Nm (1.77 - 2.21 lbf in)
Strip length	7 mm (0.2756 in)

17.1 Performance characteristics of functions

Function	Symbol	Accuracy class	Measuring range	Display range
Total active power	P	0.5 (IEC61557-12)	0 W .. 12.6 kW	0 W .. 999 GW *
Total reactive power	QA, Qv	1 (IEC61557-12)	0 var .. 16.6 kvar	0 var .. 999 Gvar *
Total apparent power	SA, Sv	0.5 (IEC61557-12)	0 VA .. 12.6 kVA	0 VA .. 999 GVA *
Total active energy	Ea	0.5 (IEC61557-12) 0.5S (IEC62053-22) 0.5 (ANSI C12.20)	0 Wh .. 999 GWh	0 Wh .. 999 GWh *
Total reactive energy	ErA, ErV	1 (IEC61557-12)	0 varh .. 999 Gvarh	0 varh .. 999 Gvarh *
Total apparent energy	EapA, EapV	0.5 (IEC61557-12)	0 VAh .. 999 GVAh	0 VAh .. 999 GVAh *
Frequency	f	0.05 (IEC61557-12)	42.5 Hz .. 69 Hz	42.50 Hz .. 69.00 Hz
Phase current	I	0.5 (IEC61557-12)	0 Arms .. 7 Arms	0 A .. 999 kA
Neutral conductor current calculated	INc	1.0 (IEC61557-12)	0.03 A .. 25 A	0.03 A .. 999 kA
Voltage	U L-N	0.2 (IEC61557-12)	10 Vrms .. 600 Vrms	0 V .. 999 kV
Voltage	U L-L	0.2 (IEC61557-12)	18 Vrms .. 1040 Vrms	0 V .. 999 kV
Power factor	PFA, PFV	0.5 (IEC61557-12)	0.00 .. 1.00	0.00 .. 1.00
Transient overvoltages	Utr	-	-	-
Voltage harmonics	Uh	Cl. 1 (IEC61000-4-7)	1 .. 65	0 V .. 999 kV
THD of voltage ¹⁾	THDu	1.0 (IEC61557-12)	0% .. 999%	0% .. 999%
THD of voltage ²⁾	THD-Ru	-	-	-
Current harmonics	Ih	Cl. 1 (IEC61000-4-7)	1 .. 65	0 A .. 999 kA
THD of current ¹⁾	THDi	1.0 (IEC61557-12)	0% .. 999%	0% .. 999%
THD of current ²⁾	THD-Ri	-	-	-
Mains signal voltage	MSV	-	-	-
Short-term flicker, long-term flicker	Pst, Plt	-	-	-

- 1) Referenced to the fundamental oscillation.
2) Referenced to the effective value.

* When the maximum total energy values are reached, the display returns to 0 W.

INFORMATION

The accuracy classes refer to the measuring inputs of the device. Upstream transformers can influence the accuracy.

For low-power current transformers, we recommend using at least 10 A primary current and a maximum cable length of 5 m. Suitable current transformers can be found in our catalog or at www.janitza.com.

17.2 Modbus addresses of frequently used measured values

Address	Format	RD/WR	Variable	Unit	Comment
19000	float	RD	_ULN[0]	V	Voltage L1-N
19002	float	RD	_ULN[1]	V	Voltage L2-N
19004	float	RD	_ULN[2]	V	Voltage L3-N
19006	float	RD	_ULL[0]	V	Voltage L1-L2
19008	float	RD	_ULL[1]	V	Voltage L2-L3
19010	float	RD	_ULL[2]	V	Voltage L3-L1
19012	float	RD	_ILN[0]	A	Apparent current, L1
19014	float	RD	_ILN[1]	A	Apparent current, L2
19016	float	RD	_ILN[2]	A	Apparent current, L3
19018	float	RD	_I_SUM3	A	Sum; $I_N=I_1+I_2+I_3$
19020	float	RD	_PLN[0]	W	Active power L1
19022	float	RD	_PLN[1]	W	Active power L2
19024	float	RD	_PLN[2]	W	Active power L3
19026	float	RD	_P_SUM3	W	Sum; $P_{sum3}=P_1+P_2+P_3$
19028	float	RD	_SLN[0]	VA	Apparent power L1
19030	float	RD	_SLN[1]	VA	Apparent power L2
19032	float	RD	_SLN[2]	VA	Apparent power L3
19034	float	RD	_S_SUM3	VA	Sum; $S_{sum3}=S_1+S_2+S_3$
19036	float	RD	_QLN[0]	var	Reactive power (mains frequency) L1
19038	float	RD	_QLN[1]	var	Reactive power (mains frequency) L2
19040	float	RD	_QLN[2]	var	Reactive power (mains frequency) L3
19042	float	RD	_Q_SUM3	var	Sum; $Q_{sum3}=Q_1+Q_2+Q_3$
19044	float	RD	_COS_PHI[0]		Fund. power factor, CosPhi; UL1 IL1
19046	float	RD	_COS_PHI[1]		Fund. power factor, CosPhi; UL2 IL2
19048	float	RD	_COS_PHI[2]		Fund. power factor, CosPhi; UL3 IL3
19050	float	RD	_FREQ	Hz	Frequency
19052	float	RD	_PHASE_SEQ		Rotating field; 1=right, 0=none, -1=left
19054*	float	RD	_WH_V[0]	Wh	Active energy L1, consumed
19056*	float	RD	_WH_V[1]	Wh	Active energy L2, consumed
19058*	float	RD	_WH_V[2]	Wh	Active energy L3, consumed
19060	float	RD	_WH_V_HT_SUML13	Wh	Active energy L1..L3
19062	float	RD	_WH_V[0]	Wh	Active energy L1, consumed
19064	float	RD	_WH_V[1]	Wh	Active energy L2, consumed
19066	float	RD	_WH_V[2]	Wh	Active energy L3, consumed
19068	float	RD	_WH_V_HT_SUML13	Wh	Active energy L1..L3, consumed, tariff 1
19070	float	RD	_WH_Z[0]	Wh	Active energy L1, delivered
19072	float	RD	_WH_Z[1]	Wh	Active energy L2, delivered
19074	float	RD	_WH_Z[2]	Wh	Active energy L3, delivered
19076	float	RD	_WH_Z_SUML13	Wh	Active energy L1..L3, delivered
19078	float	RD	_WH_S[0]	VAh	Apparent energy L1
19080	float	RD	_WH_S[1]	VAh	Apparent energy L2
19082	float	RD	_WH_S[2]	VAh	Apparent energy L3
19084	float	RD	_WH_S_SUML13	VAh	Apparent energy L1..L3
19086*	float	RD	_IQH[0]	varh	Reactive energy, inductive, L1
19088*	float	RD	_IQH[1]	varh	Reactive energy, inductive, L2
19090*	float	RD	_IQH[2]	varh	Reactive energy, inductive, L3
19092	float	RD	_IQH_SUML13	varh	Reactive energy L1..L3
19094	float	RD	_IQH[0]	varh	Reactive energy, inductive, L1
19096	float	RD	_IQH[1]	varh	Reactive energy, inductive, L2
19098	float	RD	_IQH[2]	varh	Reactive energy, inductive, L3

* The assignment of the marked device addresses does not correspond to the assignment of other devices in the UMG series.

Address	Format	RD/WR	Variable	Unit	Comment
19100	float	RD	_IQH_SUML13	varh	Reactive energy L1..L3, ind.
19102	float	RD	_CQH[0]	varh	Reactive energy, capacitive, L1
19104	float	RD	_CQH[1]	varh	Reactive energy, capacitive, L2
19106	float	RD	_CQH[2]	varh	Reactive energy, capacitive, L3
19108	float	RD	_CQH_SUML13	varh	Reactive energy L1..L3, cap.
19110	float	RD	_THD_ULN[0]	%	Harmonics, THD,U L1-N
19112	float	RD	_THD_ULN[1]	%	Harmonics, THD,U L2-N
19114	float	RD	_THD_ULN[2]	%	Harmonics, THD,U L3-N
19116	float	RD	_THD_ILN[0]	%	Harmonics, THD,I L1
19118	float	RD	_THD_ILN[1]	%	Harmonics, THD,I L2
19120	float	RD	_THD_ILN[2]	%	Harmonics, THD,I L3

17.3 Number formats

Type	Size	Minimum	Maximum
short	16 bit	-2 ¹⁵	2 ¹⁵ -1
ushort	16 bit	0	2 ¹⁶ -1
int	32 bit	-2 ³¹	2 ³¹ -1
uint	32 bit	0	2 ³² -1
float	32 bit	IEEE 754	IEEE 754

17.4 Note on saving measured values and configuration data

INFORMATION

Saving measured values and configuration data!

In the event of an **operating voltage failure** the recording can be interrupted for a maximum of 5 minutes. The following **measured values are saved by the device every 5 minutes** in a non-volatile memory:

- Comparator timer
- S0 meter readings
- Minimum, maximum and average values (without date and time)
- Energy values

The device saves configuration data immediately!

17.5 Dimensional drawings

· The figures are for illustration purposes only and are not to scale.

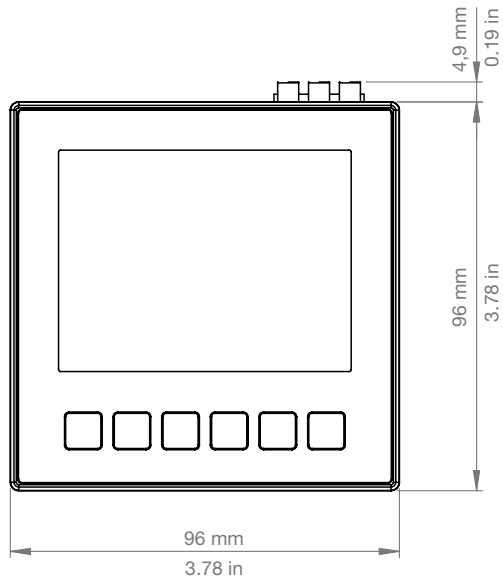
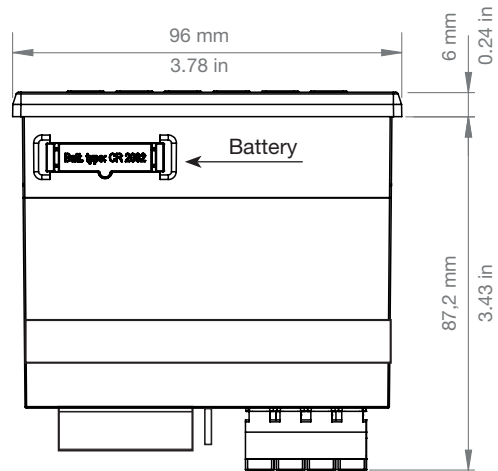

Fig. Front view



1) Bottom view

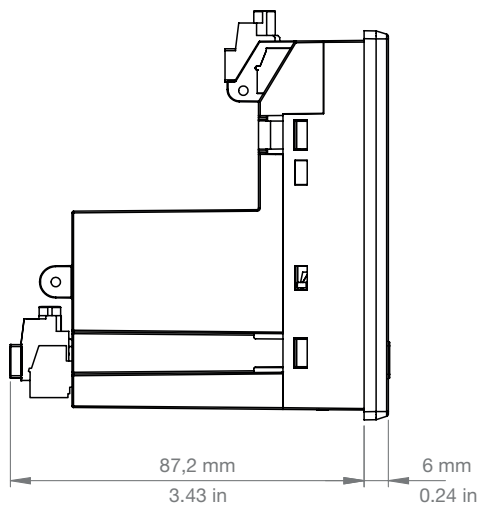

Fig. Side view

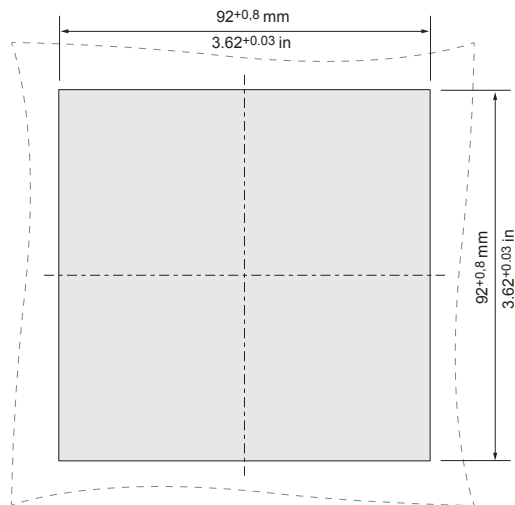
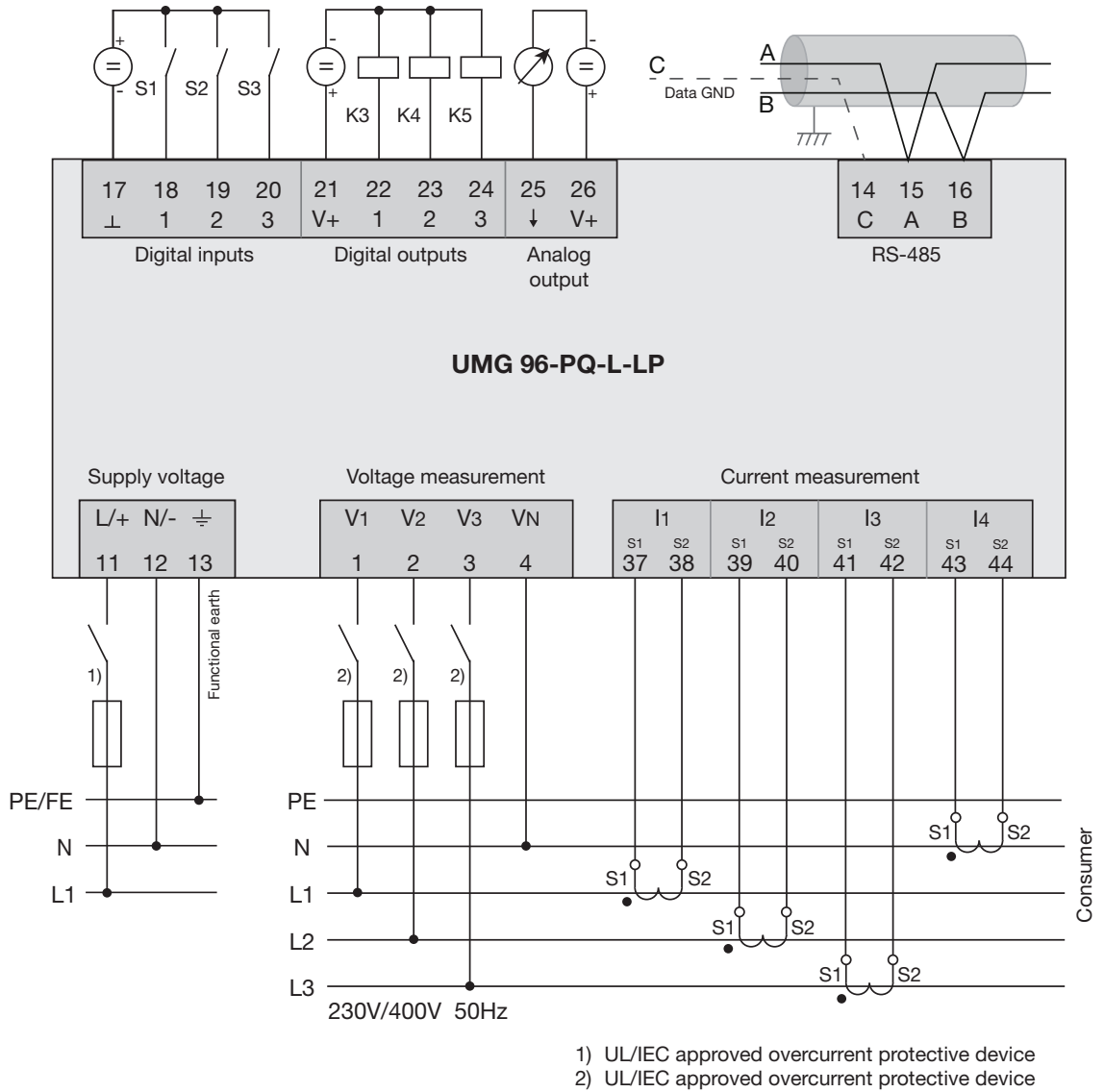

Fig. Cutout dimensions

17.6 Connection example



Janitza[®]

Janitza electronics GmbH
Vor dem Polstück 6 | 35633 Lahnau
Germany

Tel.: +49 6441 - 9642-0
info@janitza.com | www.janitza.com